

LC

Collection

Soave
Waves

+ 2

laCividina

Collection

Soave ARMCHAIR / SOFA

Waves OTTOMAN / DORMEUSE / SYSTEM

SOAVE



SOAVE cod. 1043
Left element 178 with right table

Soave

Family	Armchair / Sofa
Designer	Sebastian Herkner / 2018
Link	www.read-mo.re/soave

IT Una collezione di poltrone e divani la cui peculiarità è la ripetizione di un modulo, una forma ellittica che sovrapposta diventa base e seduta mentre curvata crea lo schienale – più discreto, più avvolgente o asimmetrico. Gli angoli smussati e le gambe in metallo, sottili ed essenziali, danno morbidezza e leggerezza a Soave, un progetto dal carattere rigoroso e coerente che, arricchito dal tavolino in appoggio, si rivela perfetto per tutti gli spazi del contract.

EN

The distinguishing feature of this collection of armchairs and sofas is the use of an elliptic shape in a number of ways. As well as being layered to form a base and a seat, it is curved into a backrest, which may be more discreet, more enveloping or asymmetrical. The rounded corners and the slender, simple metal legs give a soft, light feel to Soave, which has a consistently understated nature. When complemented by the small support table, it is perfect for all uses in the contract market and exhibition venues.

FR

Une collection de fauteuils et de canapés dont la particularité est la répétition d'un module, une forme elliptique qui, lorsqu'elle est superposée, se transforme en base et en assise et, lorsqu'elle est incurvée, crée le dossier - plus discret, plus enveloppant ou asymétrique. Les coins arrondis et les pieds en métal, fins et essentiels, apportent douceur et légèreté à Soave, un projet au caractère rigoureux et cohérent qui, enrichi par la table d'appoint, est idéal pour tous les espaces professionnels.

DE

Eine Kollektion mit Sesseln und Sofas, deren Besonderheit ein ellipsenförmiges Modul ist, das sich wiederholt. Übereinander bilden die Module Grund- und Sitzfläche, während die geschwungene Form eine Rückenlehne entstehen lässt – nach Belieben eher zurückhaltend, umhüllend oder asymmetrisch. Die abgerundeten Kanten und die grazilen, schlichten Füße aus Metall verleihen dem Modell Soave Weichheit und Leichtigkeit. Das Projekt besticht durch seinen strengen und konsequenten Charakter und ist mit seinem Beistelltischchen ideal für alle Contract-Bereiche.

SOAVE



ARMCHAIR / SOFA

SOAVE cod. 1043
Left element 178 with right table /
CUSHION cod. 10016 /
SOAVE cod.1031
Armchair with arms /
TURI TURI cod. 8773_D50 / 8774_D70
Coffee table



COLLECTION



SOAVE cod. 1035
3 seater with arms /
CUSHION cod. 10016 / 10023 /
SOAVE cod. 1030
Armchair /
MIL cod. 9095
Coffee table



SOAVE

SOAVE cod. 1043
Left element 178 with right table /
CUSHION cod. 10016



SOAVE cod. 1031
Armchair with arms



SOAVE

SOAVE cod. 1030
Armchair



ARMCHAIR / SOFA

SOAVE cod. 1035
3 seater with arms

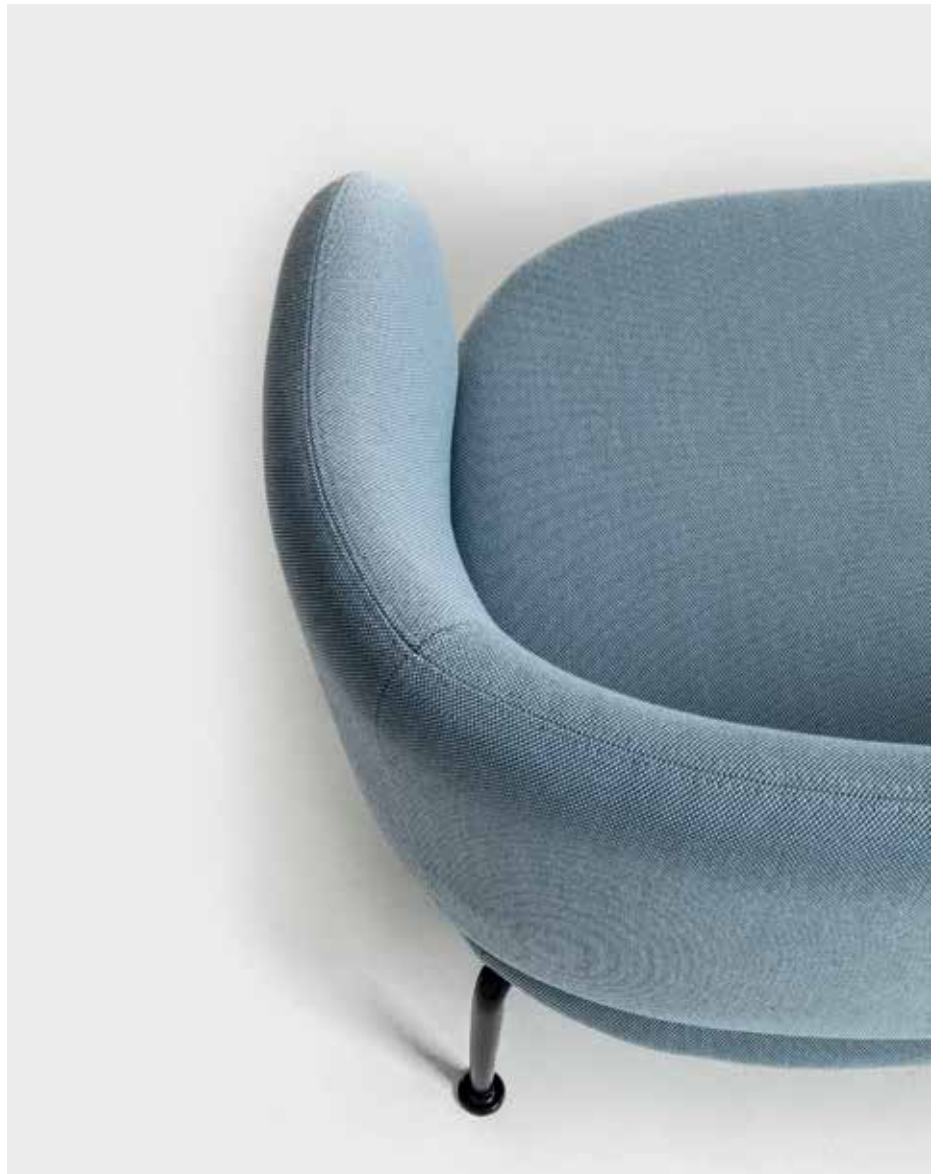

COLLECTION



ARMCHAIR / SOFA

SOAVE cod. 1043
Left element 178 with right table /
CUSHION cod. 10016 /
SOAVE cod. 1031
Armchair with arms /
MIL cod. 9095 / 9096
Coffee table



COLLECTION

Dati tecnici · Technical data · Données techniques · Technische Angaben

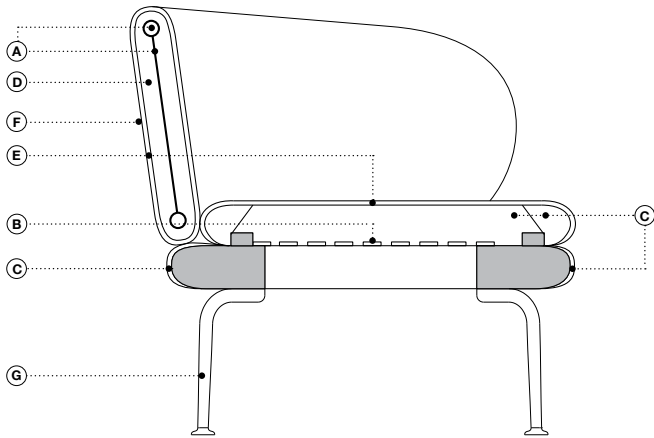

- | | |
|--|---|
| ■ Legno massiccio di faggio | ■ Solid beech |
| A. Acciaio | A. Steel |
| B. Cinghie elastiche ad alta densità | B. High density elastic straps |
| C. Poliuretano espanso ignifugo a quote differenziate | C. Flame-retardant undeformable polyurethane foam of different densities |
| D. Poliuretano ignifugo schiumato a freddo | D. Injected flame-retardant foam |
| E. Fibra di poliestere | E. Polyester fibers |
| F. Rivestimento | F. Upholstery |
| G. Acciaio verniciato | G. Lacquered steel |
-
- | | |
|--|---|
| ■ Bois de hêtre massif | ■ Massivholz Buche |
| A. Acier | A. Stahl |
| B. Sangles élastiques à haute densité | B. Elastische Gurtbänder |
| C. Mousse polyuréthane expansé ignifuge indéformable à épaisseurs différenciées | C. Feuerfester formbeständiger Polyurethanschaum in unterschiedlicher Dichte |
| D. Mousse à froid ignifuge | D. Feuerbeständiger Kaltschaum |
| E. Fibre de polyester | E. Polyester |
| F. Revêtement | F. Bezug |
| G. Acier laqué | G. Lackierter Stahl |







Caratteristiche · Features · Caractéristiques · Eigenheiten

- | | | | |
|--|---|---|--|
| <ul style="list-style-type: none"> · Telaio rinforzato per uso aree pubbliche · Poliuretano espanso ignifugo indeformabile a quote differenziate ad alta densità · Poliuretano ignifugo schiumato a freddo · Cuciture rinforzate con supporto in fibra di carbonio · Piedi personalizzabili con colore su richiesta del cliente | <ul style="list-style-type: none"> · Reinforced frame for public area use · Undeformable polyurethane foam of different densities · Injected flame-retardant foam · Reinforced stitching with carbon fiber support · Feet customizable with other colors on customer's request | <ul style="list-style-type: none"> · Structure renforcée pour une utilisation en espace public · Mousse de polyuréthane expansé ignifuge indéformable à épaisseurs différenciées · Mousse à froid ignifuge · Coutures renforcées de fibre de carbone · Pieds disponibles dans d'autres finitions sur demande | <ul style="list-style-type: none"> · Verstärkte Holzstruktur für die Nutzung in öffentlichen Bereichen · Formbeständiger Polyurethanschaum in unterschiedlicher Dichte · Feuerfester formbeständiger Polyurethanschaum · Mit Kohlefaser verstärkte Nähte Kohlefaser · Füße werden auf Wunsch des Kunden in anderen Farben gestaltet |
|--|---|---|--|

Coordinati · Matching items · Produits assortis · Abgestimmte Produkte



Finiture piano · Top finishes · Finitions de plateau · Plattenausführungen

- | | | | |
|---|--|--|--|
|  <p>Rovere spazzolato naturale
Natural brushed oak
Chêne brossé naturel
Eichenholz natur, gebürstet</p> |  <p>Rovere spazzolato grafite
Graphite brushed oak
Chêne brossé graphite
Eichenholz Graphit gebürstet</p> |  <p>MDF bianco (RAL 9016)
MDF white (RAL 9016)
MDF blanc (RAL 9016)
MDF Weiß (RAL 9016)</p> |  <p>MDF nero (RAL 9005)
MDF black (RAL 9005)
MDF noir (RAL 9005)
MDF Schwarz (RAL 9005)</p> |
|  <p>Marmo Marquina
Marquina marble
Marbre Marquina
Marquina Marmor</p> |  <p>Marmo Carrara
Carrara marble
Marbre Carrara
Carrara Marmor</p> |  <p>Marmo Calacatta
Calacatta marble
Marbre Calacatta
Calacatta Marmor</p> | |

Finitura piedi · Legs finishes · Finition de pieds · Ausführung mit Füßen



Nero
Black
Noir
Schwarz



Prugna
Plum
Prune
Pflaume



Laccato ottone
Lacquered brass
Laqué laiton
Messing lackiert



Laccato rame
Lacquered copper
Laqué cuivre
Kupfer lackiert

cod. 1030 / armchair

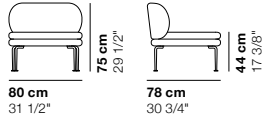

cod. 1031 / armchair with arms

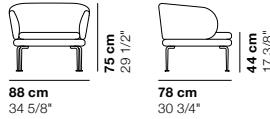

cod. 1032 / 2 seater

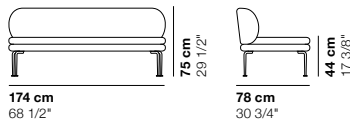

cod. 1033 / 2 seater with arms

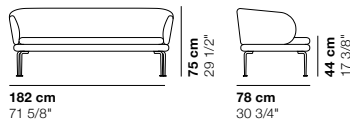

cod. 1034 / 3 seater

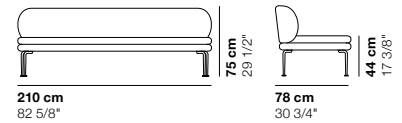

cod. 1035 / 3 seater with arms

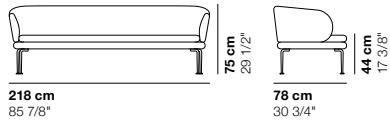

cod. 1036 / right element 178

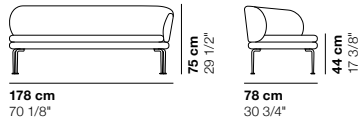

cod. 1037 / left element 178

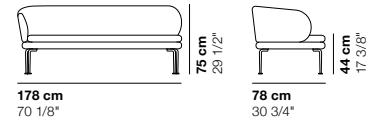

cod. 1038 / right element 214

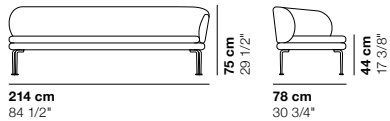

cod. 1039 / left element 214

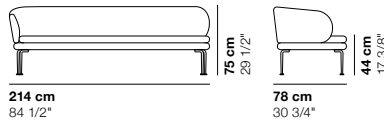

cod. 1040 / element 174 with right table

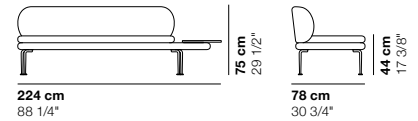

cod. 1041 / element 174 with left table

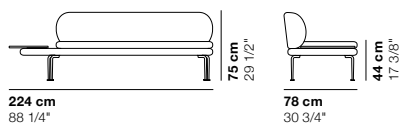

cod. 1042 / right element 178 with left table

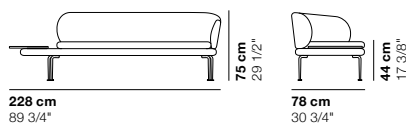

cod. 1043 / left element 178 with right table

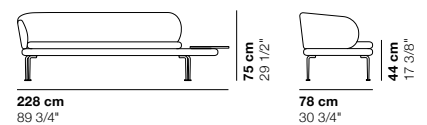



WAVES cod. 1010
Diamond ottoman /
WAVES cod. 1013
Parallel ottoman with backrest /
WAVES cod. 1014
Trapezium ottoman /
MIL cod. 9095
Coffee table

Waves

Family	Ottoman / Dormeuse / System
Designer	Constance Guisset / 2018
Link	www.read-mo.re/waves

IT Waves è una collezione di pouf ispirata al mare, alle onde morbide e gentili che increspano la superficie dell'acqua. Forme organiche che si fanno artistiche, in cui paesaggi e fiori invadono la tela con linee sinuose e colori pieni. Waves è elemento singolo ma è soprattutto composizione. Moduli con forme e volumi diversi, anche con piccolo schienale, da affiancare a piacere per arredare in modo elegante e inconsueto luoghi d'attesa o spazi espositivi. Ogni elemento nasconde nella struttura un magnete, grazie al quale i pouf si agganciano tra di loro. Completa la collezione una serie di tavolini in legno che, in linea con il nostro vivere contemporaneo, nascondono prese elettriche e USB.



Magnet

EN

Waves is a collection of poufs inspired by the sea and the soft, gentle ripples running along the surface of the water. Natural forms take on an artistic character, with the winding lines and rich colours of landscapes and flowers flooding onto the canvases. Waves poufs can be used individually, but they really come into their own in compositions. The modular items are available in a range of different shapes and sizes, including some with small backrests. They can be joined together however you like as part of a refined, original interior design scheme for waiting rooms and exhibition venues. There is a magnet hidden inside the structure of each pouf, so a number of the items can be joined together. Rounding off the collection is a selection of wooden coffee tables with concealed plug sockets and USB ports to cater to the needs of contemporary living.

FR

Waves est une collection de poufs s'inspirant de la mer, des vagues souples et douces qui animent la surface de l'eau. Des formes organiques qui deviennent artistiques, dans lesquelles les paysages et les fleurs envahissent la toile avec des lignes sinueuses et des couleurs pleines. Waves est un élément unique mais est surtout une composition. Des modules de formes et de volumes différents, également proposés avec un petit dossier, à placer côte à côte pour meubler, de façon élégante et insolite, les salles d'attente ou les espaces d'exposition. La structure de chaque élément renferme un aimant, permettant aux poufs d'être raccordés entre eux. La collection est complétée par une série de tables basses en bois qui, en accord avec notre style de vie contemporain, cachent des prises électriques et USB.

DE

Die Pouf-Kollektion Waves wird vom Meer und weichen, sanften Wellen inspiriert, die sacht die Oberfläche des Wassers kräuseln. Organische, künstlerisch wirkende Formen, die von Landschaften und Blumen mit geschmeidigen Formen und kräftigen Farben überflutet werden. Waves ist ein einzelnes Element, aber vor allem als Komposition konzipiert. Module in verschiedenen Formen und Größen, auch mit kleiner Rückenlehne, die ganz nach Wunsch für die Gestaltung von eleganten, ungewöhnlichen Warte- und Ausstellungsräumen zusammengestellt werden. In der Struktur jedes Elements ist ein Magnet verborgen, mithilfe dessen die Polsterhocker miteinander verbunden werden können. Ergänzt wird die Kollektion durch eine Reihe von kleinen Tischen aus Holz, die – ganz im Zeitgeist – unauffällig mit Steckdosen und USB-Ports ausgerüstet sind.

WAVES

WAVES cod. 1010
Diamond ottoman /
MIL cod. 9095 / 9096
Coffee table



WAVES cod. 1010
Diamond ottoman



WAVES cod. 1011
Diamond ottoman with backrest





WAVES cod. 1014
Trapezium ottoman /
WAVES cod. 1015
Trapezium ottoman with backrest /
WAVES cod. 1012
Parallel ottoman /
WAVES cod. 1013
Parallel ottoman with backrest





WAVES cod. 1010
Diamond ottoman /
WAVES cod. 1011
Diamond ottoman with backrest /
WAVES cod. 1017
Hexagon ottoman /
MIL cod. 9095 / 9096
Coffee table /
TURI TURI cod. 8772_D40
Coffee table

WAVES cod. 1016
Leaf dormeuse



WAVES

WAVES cod. 1016
Leaf dormeuse /
MIL cod. 9095 / 9096
Coffee table





WAVES

WAVES cod. 1010
Diamond ottoman /
WAVES cod. 1011
Diamond ottoman with backrest /
WAVES cod. 1017
Hexagon ottoman



EIGHT ELEMENTS  ENDLESS COMPOSITIONS

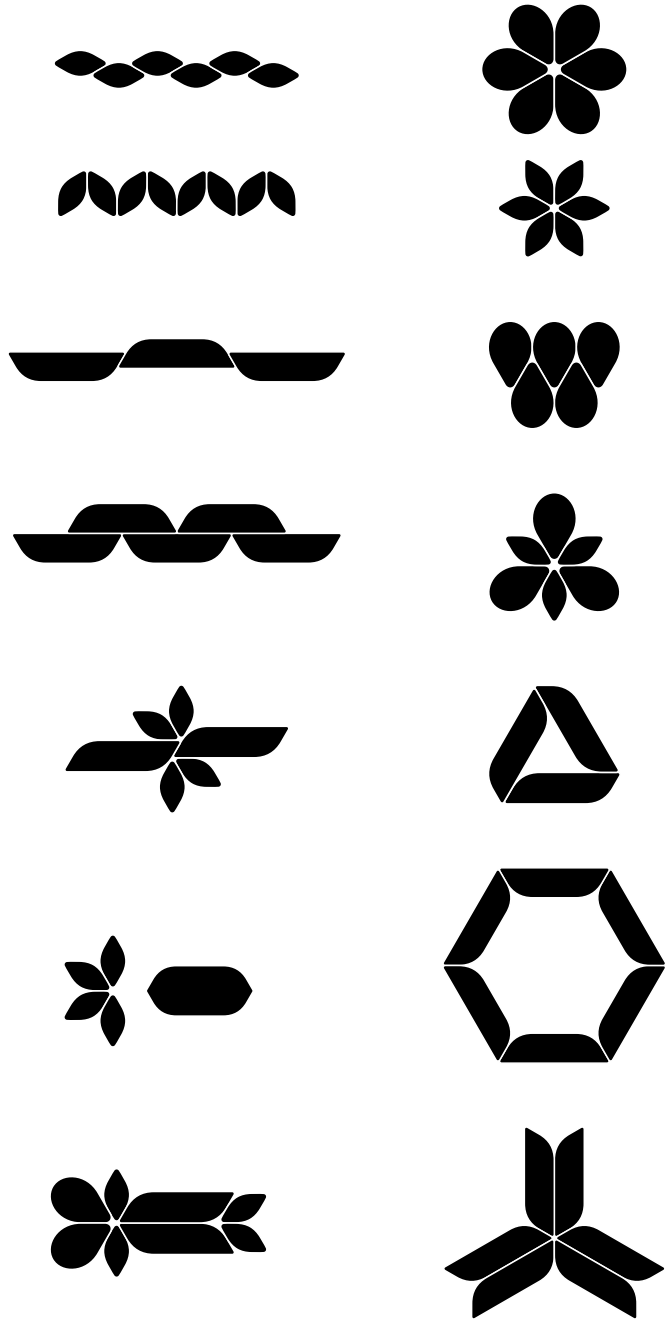



WAVES cod. 1015
Trapezium ottoman with backrest /
WAVES cod. 1014
Trapezium ottoman /
WAVES cod. 1013
Parallel ottoman with backrest /
WAVES cod. 1012
Parallel ottoman /
TURI TURI cod. 8772_D40
Coffee table /
MIL cod. 9095 / 9096
Coffee table

Dati tecnici · Technical data · Données techniques · Technische Angaben

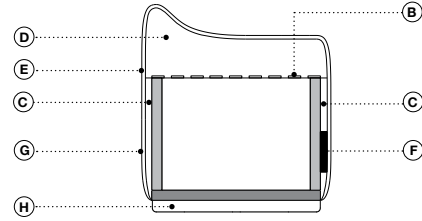
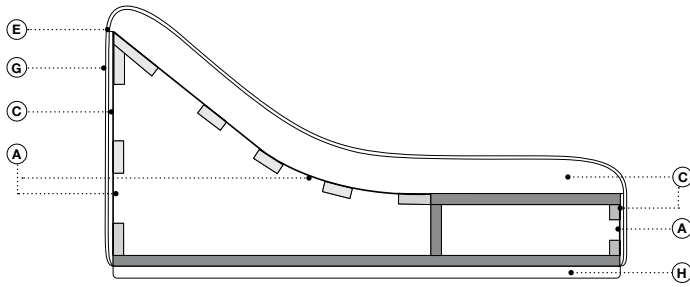

- Legno massiccio di abete
- Legno massiccio di faggio
- Legno multistrato di faggio

- A.** Pannello masonite
- B.** Cinghie elastiche ad alta densità
- C.** Poliuretano espanso ignifugo a quote differenziate
- D.** Poliuretano ignifugo schiumato a freddo
- E.** Fibra di poliestere
- F.** Magnete
- G.** Rivestimento
- H.** MDF

- Solid fir
- Solid beech
- Multilayered beech

- A.** Masonite panel
- B.** High density elastic straps
- C.** Flame-retardant undeformable polyurethane foam of different densities
- D.** Injected flame-retardant foam
- E.** Polyester fibers
- F.** Magnet
- G.** Upholstery
- H.** MDF

- Bois de sapin massif
- Bois de hêtre massif
- Multiplis de hêtre

- A.** Panneau de particules
- B.** Sangles élastiques à haute densité
- C.** Mousse polyuréthane expansé ignifuge indéformable à épaisseurs différenciées
- D.** Mousse à froid ignifuge
- E.** Fibre de polyester
- F.** Aimant
- G.** Revêtement
- H.** MDF

- Massivholz Tanne
- Massivholz Buche
- Buchenschichtholz

- A.** Holzfaserplatte
- B.** Elastische Gurtbänder
- C.** Feuerfester formbeständiger Polyurethanschaum in unterschiedlicher Dichte
- D.** Feuerbeständiger Kaltschaum
- E.** Polyester
- F.** Magnet
- G.** Bezug
- H.** MDF

Caratteristiche · Features · Caractéristiques · Eigenheiten

- Telaio rinforzato per uso aree pubbliche
- Poliuretano espanso ignifugo indeformabile a quote differenziate ad alta densità
- Poliuretano ignifugo schiumato a freddo
- Cuciture rinforzate con supporto in fibra di carbonio
- Sedute modulari agganciabili con magnete

- Reinforced frame for public area use
- Undeformable polyurethane foam of different densities
- Injected flame-retardant foam
- Reinforced stitching with carbon fiber support
- Modular seats to be joined with magnet

- Structure renforcée pour une utilisation en espace public
- Mousse polyuréthane expansé ignifuge indéformable à épaisseurs différenciées
- Mousse à froid ignifuge
- Coutures renforcées de fibre de carbone
- Sieges modulaires à joindre avec aimant

- Verstärkte Holzstruktur für die Nutzung in öffentlichen Bereichen
- Formbeständige Polyurethanschaum in unterschiedlicher Dichte
- Feuerfester formbeständige Polyurethanschaum
- Verstärkte Säume mit Stütz aus Kohlefaser
- Modular Sitze mit Magnet verbindbar

Coordinati · Matching items · Produits assortis · Abgestimmte Produkte



MIL



TURI TURI



SCANCARÒ



BOLD



DUOTONE

Finiture · Finishes · Finitions · Ausführungen



- Grigio scuro (RAL 7021)
- Dark grey (RAL 7021)
- Gris foncé (RAL 7021)
- Dunkelgrau (RAL 7021)

cod. 1010 / **diamond ottoman**

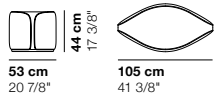

cod. 1011 / **diamond ottoman with backrest**

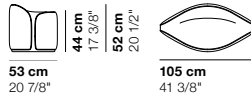

cod. 1012 / **parallel ottoman**

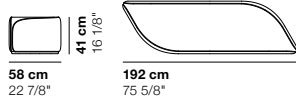

cod. 1013 / **parallel ottoman with backrest**



cod. 1014 / **trapezium ottoman**

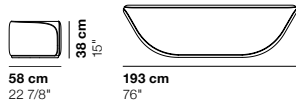

cod. 1015 / **trapezium ottoman with backrest**

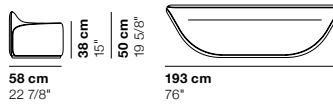

cod. 1016 / **leaf dormeuse**

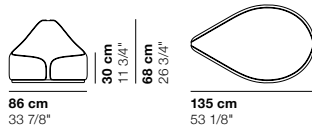

cod. 1017 / **hexagon ottoman**

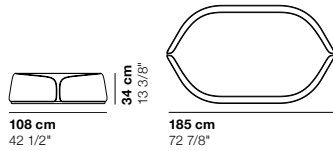

cod. 1018 / **coffee table**

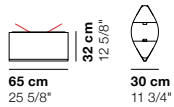

LaCividina srl

HEADQUARTERS**/ PRODUCTION**

Via Cividina 176
33035 Martignacco
Udine Italy

SHOWROOM

Via Lungolavia 1
33035 Martignacco
Udine Italy

T. + 39 0432 677433
F. + 39 0432 677480
info@lacividina.com
www.lacividina.com



Press Office

Carter&Bennett

pr@carterandbennett.com

tel. +39 0432 1746101

/ La Cividina s.r.l., al fine di migliorare caratteristiche tecniche e qualitative della sua produzione, si riserva di apportare, anche senza preavviso, tutte le modifiche che si rendessero necessarie.

/ With a view to improving the technical characteristics and quality of its products, La Cividina s.r.l. reserves the right to develop its products at any time without notice.

/ Afin d'améliorer les caractéristiques techniques et qualitatives de sa production, La Cividina s.r.l. se réserve d'apporter, même sans préavis, toutes les modifications qui se rendront nécessaires.

/ Zur Verbesserung der technischen und qualitativen Merkmale behält sich La Cividina s.r.l. vor, alle notwendig erscheinenden Produktionsänderungen auch ohne Vorankündigung durchzuführen.

Company Art Director

Luca Botto

Graphic Design

Designwork

Photo

Alessandro Paderni / Studio Eye

Colour Separation

Luce Group

2D development

Federico Bravo

Copywriting

Carter&Bennett

Translation

Trad&Co

Made and printed in Italy

Grafiche Manzanese

April 2018

LaCividina s.r.l

**HEADQUARTERS
/ PRODUCTION**

Via Cividina 176
33035 Martignacco
Udine Italy

SHOWROOM

Via Lungolavia 1
33035 Martignacco
Udine Italy

T. + 39 0432 677433

F. + 39 0432 677480

info@lacividina.com

www.lacividina.com