

IDEAL LUX[®]

OUTDOOR | 2017

MODERN - MINIMALIST - INDUSTRIAL - URBAN - ECLECTIC

INDICE GENERALE

General index / Index général / Allgemeines Inhaltsverzeichnis / Indice general / Оглавление

Azienda / Company / Entreprise Unternehmen / Empresa / Компания	4
Indice alfabetico / Alphabetical index / Index alphabétique Alphabetisches Inhaltsverzeichnis / Índice alfabético Оглавление в алфавитном порядке	10
Indice tipologie / Typology index / Index typologies Inhaltsverzeichnis Typen / Índice de tipologías Оглавление по типологии	12
Tavolo e terra / Table and floor / Bureau et sol Tisch und Boden / Sobremesa y De pie Настольные и торшеры	18
Parete e soffitto / Wall and ceiling / Mural et plafond Wand und Decke / Pared y De techo Настенные и потолочные	84
Incasso / Recessed / Á encastrar Einbau / Empotrado / Споты	142
Lampadine e accessori / Light bulbs and accessories / Ampoules et accessoires Leuchtmittel und Zubehör / Bombillas y accesorios / Лампочки и аксессуары	154
Informazioni generali / General information / Informations générales Allgemeine Informationen / Información general / Общая информация	168
Indice per codice / Code index / Index des codes Inhaltsverzeichnis für EAN-Code / Índice por código / Оглавление по кодам	173

Note / Notes / Notes / Anmerkungen / Anotaciones / Примечание

Ideal Lux s.r.l. si riserva il diritto di apportare, in qualunque momento e senza preavviso, tutte le modifiche necessarie a migliorare la qualità degli articoli illustrati nel presente catalogo. / Ideal Lux s.r.l. reserves the right to make, at any time and without notice, all necessary changes to improve the quality of the items of this catalogue. / Ideal Lux s.r.l. se réserve le droit d'apporter, à tout moment et sans préavis, les modifications nécessaires pour améliorer la qualité des articles dans ce catalogue. / Ideal Lux s.r.l. behält sich das Recht vor, in jedem Moment und ohne Mitteilung, alle zur Verbesserung der Qualität der in diesem Katalog enthaltenen Artikel notwendigen Änderungen vorzunehmen. / La sociedad se reserva el derecho, cuando así lo considere oportuno, de aportar sin preaviso todas las modificaciones necesarias para mejorar la calidad de los artículos ilustrados en este catálogo. / Ideal Lux s.r.l. имеет право в любой момент и без предупреждения внести изменения для улучшения качества продукции данного каталога.

Tutti i nostri prodotti si alimentano con tensione nominale di 240V e sono conformi alle direttive CE. / All our products work with nominal voltage of 240V and comply with EU legislation. / Tous nos produits ont une alimentation avec tension nominale de 240V et ils sont conformes aux directives CE. / All unsere Produkte sind für Netzanschluss mit Nennspannung 240V und entsprechen der CE-Norm. / Todos nuestros productos se nutren con tensión nominal de 240V y están conformes a las normas CE. / Вся наша продукция идет на 240V и соответствуют нормативам ЕС.

Community Design Pending Nr. 001996372 002022038 002194993 002395392 002621862 002943449 003734342

Copyright 2017 © IDEAL LUX S.r.l. – All rights reserved – Tutti i diritti sono riservati

METEL



COMPANY

*C'è un gesto quotidiano che ognuno di noi compie al sopraggiungere del buio.
Un rito familiare che rappresenta gioia, sicurezza, momento dedicato allo stare insieme.
Accendere una luce è indubbiamente un'azione semplice ma carica di significati.
Da qui inizia la nostra storia.*

*There is a daily gesture that we each do when darkness comes.
A familiar ritual representing joy, certainty and a moment dedicated to spending time together.
To turn on the light is a simple action but full of meaning.
This is where our story begins.*

Come spesso capita tutto comincia con un'idea semplice e quasi casuale. Un'intuizione che si trasforma in un'attività concreta e portata avanti con tenacia e costanza. Ideal Lux si è presentata nel mercato dell'illuminazione oltre 40 anni fa. Partita da una piccola realtà imprenditoriale, è stata capace di estendere i propri confini. Oggi rappresenta un'azienda solida, esponente di punta in Italia dell'affordable design nel settore dell'illuminazione decorativa, con sede principale nella terraferma veneziana, un team multiculturale dove si parlano 9 lingue e prodotti venduti a livello globale. La capacità di coniugare qualità, servizio, ampia gamma nella scelta del prodotto e convenienza sono ciò che guida da sempre Ideal Lux, che ha saputo interpretare i cambiamenti attraverso proposte funzionali e al passo con le tendenze del momento.



Giovambattista Strano - Fondatore Ideal Lux

As it often happens, everything began with a simple idea; an instinct that materialized into action and grew with diligence and tenacity. Ideal Lux entered the lighting market as a small, entrepreneurial firm over 40 years ago and through decades of hard work we have expanded well beyond our humble beginnings. Headquartered in the outskirts of Venice with a multicultural team and with products sold at a global level, the Ideal Lux brand continues to flourish in the decorative lighting sector thanks to a wide array of products, affordable prices and swift, accurate service, offered in 9 different languages.



Giovambattista Strano oggi

LA PERSONA AL CENTRO DI OGNI SCELTA

The individual at the centre of every choice

Una lampada può essere al tempo stesso oggetto di design e fonte di luce capace di creare una particolare atmosfera modificando e valorizzando lo spazio che ci circonda.

Al centro di ogni scelta per noi c'è sempre la persona, il suo stile di vita e la sua ricerca verso la soluzione più adatta a una precisa esigenza, alla realizzazione di un sogno o di un'idea. Per questo, il nostro obiettivo è di creare prodotti in grado di soddisfare bisogni e desideri diversi, coniugando design, funzionalità e prezzi facilmente accessibili.

A lamp can at once be a source of light and an object of design able to create an atmosphere that not only illuminates but enhances the surrounding space. Ideal Lux has always followed a people-centred approach to business and design, a philosophy of putting the individual at the centre of every choice. Our goal is to create products that embody this philosophy. Light is more than function it is the articulation of personal aspiration, the realization of a dream or idea. Our creations cater to specific needs, lifestyles, and desires at accessible prices.



IDEE, SOLUZIONI, NOVITÀ

Ideas, solutions, novelties

Ogni anno ci impegniamo a rinnovare il nostro catalogo, arricchendolo gli stili e proponendo ai clienti prodotti sempre nuovi, dedicati alla casa, ma anche agli ambienti progettati per la condivisione, il lavoro, lo studio, gli spazi pubblici con linee che vanno dal classico al contemporaneo, dal minimale al vintage, dall'urban allo shabby chic. In sintesi un prodotto per ogni esigenza; a ogni personalità il suo stile.

Every year we put considerable effort into revamping our catalogue. We expand the choice of styles; providing new solutions for homes, offices, studios, and public spaces with lines ranging from classic to contemporary, from minimal to vintage, from urban to shabby chic. A solution for every need, for every personality and for every style.



ASCOLTO

Listening

Ascoltare i clienti è fondamentale per realizzare prodotti pensati per le loro necessità. Questo rappresenta per noi un valore fondante, l'attività che ci impegna maggiormente e alla quale dedichiamo le nostre migliori energie e i nostri progetti. Ma tutto ciò da solo non basta. Essere veloci è un'altra importante caratteristica che offriamo con il nostro servizio di pronta consegna.

In un mercato altamente competitivo è inoltre necessario essere sempre vicini al cliente in tutte le fasi dell'acquisto, da quelle che lo precedono a quelle che coinvolgono il servizio post-vendita.

Listening to our client's wishes and demands is engrained in our design process. It is a value that drives our work and a priority to which we dedicate our best efforts. In a competitive market, we believe that it is crucial to be present for the customer in all the phases of the sale, from concept to prompt delivery and even after the sale. It's simple, we create products to meet your desires we ensure prompt delivery and a reliable customer service.



LA FORZA DEL TEAM

The strength of the team



Ideal Lux oggi è soprattutto un gruppo di persone, giovani e dinamiche, che vivono il presente e sono proiettate verso il futuro, con la capacità di mettersi in discussione e motivate dalla voglia di migliorarsi sempre. Un team eterogeneo unito dalla passione per il lavoro, una squadra vitale dotata di grande senso di responsabilità e sensibilità verso la mission aziendale.

Ideal Lux is first and foremost a group of people dedicated to the Ideal Lux mission. We have built a young, dynamic, team that have a pulse on what is current while continually thinking forward. We are a team united by the passion for work and driven by the will to improve, always.

MODELLO ETICO DI BUSINESS

Our ethical business model

Ci ispiriamo ad un modello etico di business, i cui valori sono fiducia, umiltà, trasparenza e affidabilità. Dare fiducia ai nostri clienti e ai nostri collaboratori ci permette di ricevere fiducia a nostra volta e di costruire rapporti destinati a durare nel tempo. Umiltà è la capacità di farsi carico dei propri errori e trasformare le difficoltà in occasioni per migliorare. Essere trasparenti e affidabili è l'atteggiamento che adottiamo con tutti e che ci aspettiamo di ricevere dagli altri. Questi sono per noi presupposti etici imprescindibili per instaurare rapporti commerciali prolifici e a lungo termine e sono alla base della crescita del nostro business.

Ideal Lux embraces an ethical model of business, which values trust, humility, transparency and reliability. We cultivate long term relationships by trusting to our partners and customers and earning their trust in return. We are humble in our work, taking ownership of our mistakes and transforming criticism into inspiration. We are transparent and reliable with our stakeholders and we hold our stakeholders to the same high standards. These ethical assumptions are instrumental to establishing prolific, long term commercial relationships. These serve as the foundation upon which we have and continue to build our business.



Giovambattista Strano e figli

INDICE ALFABETICO

Alphabetical index / Index alphabétique / Alphabetisches Inhaltsverzeichnis / Índice alfabético /
Оглавление в алфавитном порядке

Acqua	68	Down	100	Mercurio	62	Tronco	46
Andromeda	120	Eclisse	42	Midras	52	Twin	98
Anna	40	Edo Outdoor	56	Mike	138	Up	94
Apollo	108	Francy	122	Minitommy	74	Vega	66
Armony	28	Gas	48	Park	148	Venus	60
Astro	110	Germana	126	Polaris	64	Xeno	86
Bamboo	70	Giove	124	Pulsar	58	Zenith	72
Base	114	Green	50	Rex	136	Zeus	88
Bee	102	Gun	112	Rocket	152		
Berta	130	Iko	96	Rubik	104		
Birillo Outdoor	24	Inside	78	Sirio	54		
Bubble	128	Keope	106	Snif Round	116		
Ceci	146	Krypton	82	Snif Square	118		
Cecilia	150	Leti	144	Sole	22		
Cima	38	Live	26	Sound	34		
Clio	32	Lucia	132	Symphony	30		
Cometa	140	Luna	20	Terra	80		
Concerto	36	Maddi	134	Tetris	92		
Dot	90	Marte	44	Tommy	76		



Base

Corpo luce in alluminio pressofuso rifinito con vernice a polveri opaca. Doppio diffusore, superiore e inferiore, in vetro temperato trasparente.

Pagina 114

LAMPADE DA TAVOLO E TERRA

Table and floor lamps / Lampes de table e lampadaires / Tischleuchten und Stehleuchten / Lámparas de sobremesa y de pie / Настольные лампы и торшеры

























































Midras

Corpo luce in alluminio tornito, rifinito in vernice opaca disponibile nei colori antracite, bianco, grigio o nero. Diffusore in vetro temperato.

Pagina 52

LAMPADE DA PARETE E SOFFITTO

Wall and ceiling lamps / Appliques et plafonniers / Wandleuchten und Deckenleuchten / Lámpara de pared y de techo / Настенные и потолочные светильники

											
Armony 28	Symphony 30	Clio 32	Sound 34	Concerto 36							
											
Eclisse 42	Marte 44	Tronco 46	Gas 48	Zenith 72	Minitommy 74	Tommy 76	Terra 80	Cima 38	Anna 40		
											
Xeno 86	Zeus 88	Dot 90	Iko 96	Up 94	Rubik 104	Tetris 92	Down 100	Twin 98	Bee 102		
											
Keope 106	Apollo 108	Astro 110	Gun 112	Base 114	Snif Round 116	Snif Square 118					
											
Andromeda 120	Francy-1 122	Francy-2 122	Giove 124								
											
Bubble 128	Germana 126	Berta 130	Lucia-1 132	Lucia-2 132	Maddi-1 134	Maddi-2 134	Rex-1 136	Rex-2 136	Rex-3 136		
											
Mike 138	Cometa 140	Gun 112									
											
Armony 28	Symphony 30	Clio 32	Sound 34	Concerto 36							



Xeno

Corpo luce in alluminio rifinito con vernice opaca a polveri. Diffusori orientabili con vetro temperato trasparente.

Pagina 86

LAMPADE A SOSPENSIONE

Pendant lamps / Suspensions / Pendelleuchten / Lámpara colgante / Люстры и подвесы



Armony 28



Symphony 30



Clio 32



Sound 34



Concerto 36



Sole 22



Anna 40

LAMPADE A INCASSO

Recessed lights / Lampes à encastrer / Einbauleuchte / Lámpara empotrada / Встраиваемый светильник



Leti Round 144



Leti Square 144



Ceci Round 146



Ceci Square 146



Park Round 148



Park Square 148



Cecilia 150



Rocket-1 152



Rocket-2 152



Leti

Corpo luce e diffusore in resina ad alte prestazioni: inattaccabile dalla corrosione sia di agenti atmosferici che di fertilizzanti chimici, colori stabilizzati da trattamento U.V., resistente a sbalzi termici da -60° C a + 90° C.

Pagina 144



**FLOOR
AND TABLE**

Luna

Corpo luce-diffusore in materiale plastico di colore bianco opaco. Fornito completo di cavo e spina.

Matt white plastic-diffuser. Provided with power cable and plug. / Corps lumineux-diffuseur en matière plastique de couleur blanc mat. C'est fourni complet de câble et fiche. / Licht- und Lichtverteilerkörper aus Plastik. Komplet mit Kabel und Stecker. / Cuerpo de luz-difusor en material plástico de color blanco opaco. Dotado completo de cable y espina. / Корпус света-рассеиватель из пластмассового материала белого матового цвета. Поставляется вместе со шнуром и вилкой.



⊙ ⊞ IP44
⇒ 50 ↑ 50 ⇨ 50 cm
max 1 x 60W E27
115450 PT1 D60



⊙ ⊞ IP44
⇒ 40 ↑ 40 ⇨ 40 cm
max 1 x 60W E27
115443 PT1 D40



⊙ ⊞ IP44
⇒ 30 ↑ 30 ⇨ 30 cm
max 1 x 60W E27
115436 PT1 D30





Sole

Diffusore in materiale plastico di colore bianco opaco. Fornito completo di cavo e spina. Sospensione con montatura in alluminio verniciato a polveri.

Matt white plastic diffuser. Supplied with cable and plug. Pendant version equipped with powder coated aluminium frame. / Diffuseur de matière plastique de couleur blanc mat. Equipé complet de câble et fiche. Suspension avec structure en aluminium vernie à poudre. / Lichtverteiler aus Plastik in weiß matt. Komplet mit Kabel und Stecker. Pendelleuchte mit Halterung aus Aluminium pulverlackiert. / Difusor en material plástico de color blanco opaco. Dotado completo de cable y enchufe. Colgante con armazón en aluminio barnizado a polvos. / Рассеиватель из пластмассового материала белого матового цвета. Полностью снабжен шнуром и вилкой. Подвесы с алюминиевой арматурой порошковой окраски.



IP44
 ø 50 ↑ 65/143,5 cm
 max 1 x 60W E27
 136011 SP1 Big



IP44
 ø 40 ↑ 55/130 cm
 max 1 x 60W E27
 136004 SP1 Medium



IP44
 ø 30 ↑ 38/121 cm
 max 1 x 60W E27
 135991 SP1 Small



IP44
 ø 50 ↑ 48 cm
 max 1 x 60W E27
 081021 PT1 Big



IP44
 ø 40 ↑ 38 cm
 max 1 x 60W E27
 061849 PT1 Medium



IP44
 ø 30 ↑ 30 cm
 max 1 x 60W E27
 061832 PT1 Small



Birillo Outdoor

Corpo luce-diffusore in materiale plastico di colore bianco opaco. Fornito completo di cavo e spina.

White matt plastic reflecting body-diffuser. Supplied with electrical cable and plug. / Corps lumineux-diffuseur de matière plastique en couleur blanc mat. Fourni complet de câble et fiche. / Lichtkörper-Verteiler aus Plastik weiß matt. Kabel und Stecker mitgeliefert. / Cuerpo de luz-difusor en material plástico de color blanco opaco. Dotado completo de cable y enchufe. / Корпус света-рассеиватель из пластмассового материала белого матового цвета. Снабжен шнуром и вилкой.



Ø 22 ↑ 40 cm
max 1 x 60W E27
131955 TL1



Live

Apparecchio mobile senza cavi, con led alimentati da batterie ricaricabili e luce a variazione di colore regolabile RGB. Corpo luce-diffusore in policarbonato bianco opaco. Autonomia batterie di 10 ore.

Wireless mobile device with LED sources equipped with rechargeable batteries and light colour RGB changing function. Matt white polycarbonate light body-diffuser. Batteries autonomy 10 hours. / Appareil mobile sans câbles, avec led alimentés par piles rechargeables et lumière à variation de couleur réglable RGB. Corps lumineux-diffuseur en polycarbonate blanc mat. Autonomie des piles de 10 heures. / Kabelloses Mobilgerät, mit LED durch wiederaufladbare Batterien versorgt, RGB-Lichtfarbe einstellbar. Lichtkörper-/Verteiler aus Polycarbonat weiß matt. Batteriedauer 10 Stunden. / Aparato móvil sin cables, con led alimentado por baterías recargables y luz a variación de color regulable RGB. Cuerpo luz-difusor en policarbonato blanco opaco. Autonomía baterías de 10 horas. / Передвижной прибор без проводов, диоды работают на заправляемых батарейках и свет с регулируемыми цветовыми вариациями КЭС. Корпус света-рассеиватель из белого матового поликарбоната. Автономность батареек 10 часов.

LED Sorgente luminosa LED a luce fredda, 30.000 h di durata.

ON OFF Lampada con interruttore integrato.



			
IP65 LED	IP65 LED	IP65 LED	IP65 LED
ø 18,5 ↑ 27,5 cm max 1 x 2,5W LED / 10 Lm	ø 18,5 ↑ 23,5 cm max 1 x 2,5W LED / 10 Lm	ø 13,5 ↑ 18 cm max 1 x 2,5W LED / 10 Lm	ø 20 ↑ 17 cm max 1 x 2,5W LED / 10 Lm
138886 TL1 Lumetto	138893 TL1 Campana	138879 TL1 Uovo	138800 TL1 Sfera





Armony

Montatura in alluminio pressofuso e tornito, rifinito con vernici a polveri. Diffusore in materiale plastico bianco opaco.

Turned die-cast aluminium frame, finished with matt powder coating. Plastic diffuser with matt white finish. / Monture en métal coulé sous pression et travaillé sur tour, finie avec vernis à poudre. Diffuseur en matière plastique blanc mat. / Gestell aus gedrehtem Aluminiumspritzguss, pulverlackbeschichtet. Lichtverteiler aus Plastik weiß matt. / Armazón en aluminio fundido y torneado, acabado con barnices a polvos. Difusor en material plástico blanco opaco. / Арматура из литого выточенного алюминия порошковой окраски. Рассеиватель из матового белого пластикового материала.

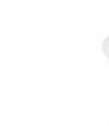

- Antracite
- Bianco
- Grigio
- Nero



ø 28 ↑ 93/118,5 cm
max 1 x 60W E27
149486 SP1 Antracite
148922 SP1 Bianco
149509 SP1 Grigio
149493 SP1 Nero



ø 28 ↑ 23 cm
max 1 x 60W E27
149455 FL1 Antracite
144221 FL1 Bianco
149479 FL1 Grigio
149462 FL1 Nero



→ 28 ↑ 27,5 ↗ 34,5 cm
max 1 x 60W E27
147291 AP1 Antracite
136172 AP1 Bianco
147314 AP1 Grigio
147307 AP1 Nero



ø 28 ↑ 78 cm
max 1 x 60W E27
147352 PT1 H60 Antracite
136141 PT1 H60 Bianco
147376 PT1 H60 Grigio
147369 PT1 H60 Nero



ø 28 ↑ 58 cm
max 1 x 60W E27
147338 PT1 H40 Antracite
136134 PT1 H40 Bianco
147321 PT1 H40 Grigio
147345 PT1 H40 Nero

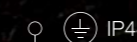

ø 70 ↑ 215 cm
max 3 x 60W E27
147413 PT3 Antracite
136165 PT3 Bianco
147406 PT3 Grigio
147420 PT3 Nero

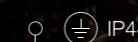

→ 75 ↑ 215 ↗ 28 cm
max 2 x 60W E27
147383 PT2 Antracite
136158 PT2 Bianco
147390 PT2 Grigio
145112 PT2 Nero

Symphony

Montatura in alluminio pressofuso e tornito, rifinito con vernici a polveri. Diffusore in materiale plastico bianco opaco.

Turned die-cast aluminium frame, finished with matt powder coating. Plastic diffuser with matt white finish. / Monture en métal coulé sous pression et travaillé sur tour, finie avec vernis à poudre. Diffuseur en matière plastique blanc mat. / Gestell aus gedrehtem Aluminiumspritzguss, pulverlackbeschichtet. Lichtverteiler aus Plastik weiß matt. / Armazón en aluminio fundido y torneado, acabado con barnices a polvos. Difusor en material plástico blanco opaco. / Арматура из литого выточенного алюминия порошковой окраски. Рассеиватель из матового белого пластикового материала.



IP44

ø 20 ↑ 34,5/119,5 cm
max 1 x 60W E27

149813 SP1 Antracite
149844 SP1 Bianco
149851 SP1 Grigio
149868 SP1 Nero



IP44

ø 20 ↑ 23 cm
max 1 x 60W E27

144207 PL1 Antracite
149783 PL1 Bianco
149790 PL1 Grigio
149806 PL1 Nero



IP44

→ 20 ↑ 28,5 ↗ 27,5 cm
max 1 x 60W E27

135946 AP1 Antracite
146577 AP1 Bianco
146591 AP1 Grigio
146584 AP1 Nero



IP44

ø 20 ↑ 79 cm
max 1 x 60W E27

135953 PT1 H60 Antracite
146966 PT1 H60 Bianco
146959 PT1 H60 Grigio
146942 PT1 H60 Nero



IP44

ø 20 ↑ 59 cm
max 1 x 60W E27

135960 PT1 H40 Antracite
146911 PT1 H40 Bianco
146928 PT1 H40 Grigio
146935 PT1 H40 Nero

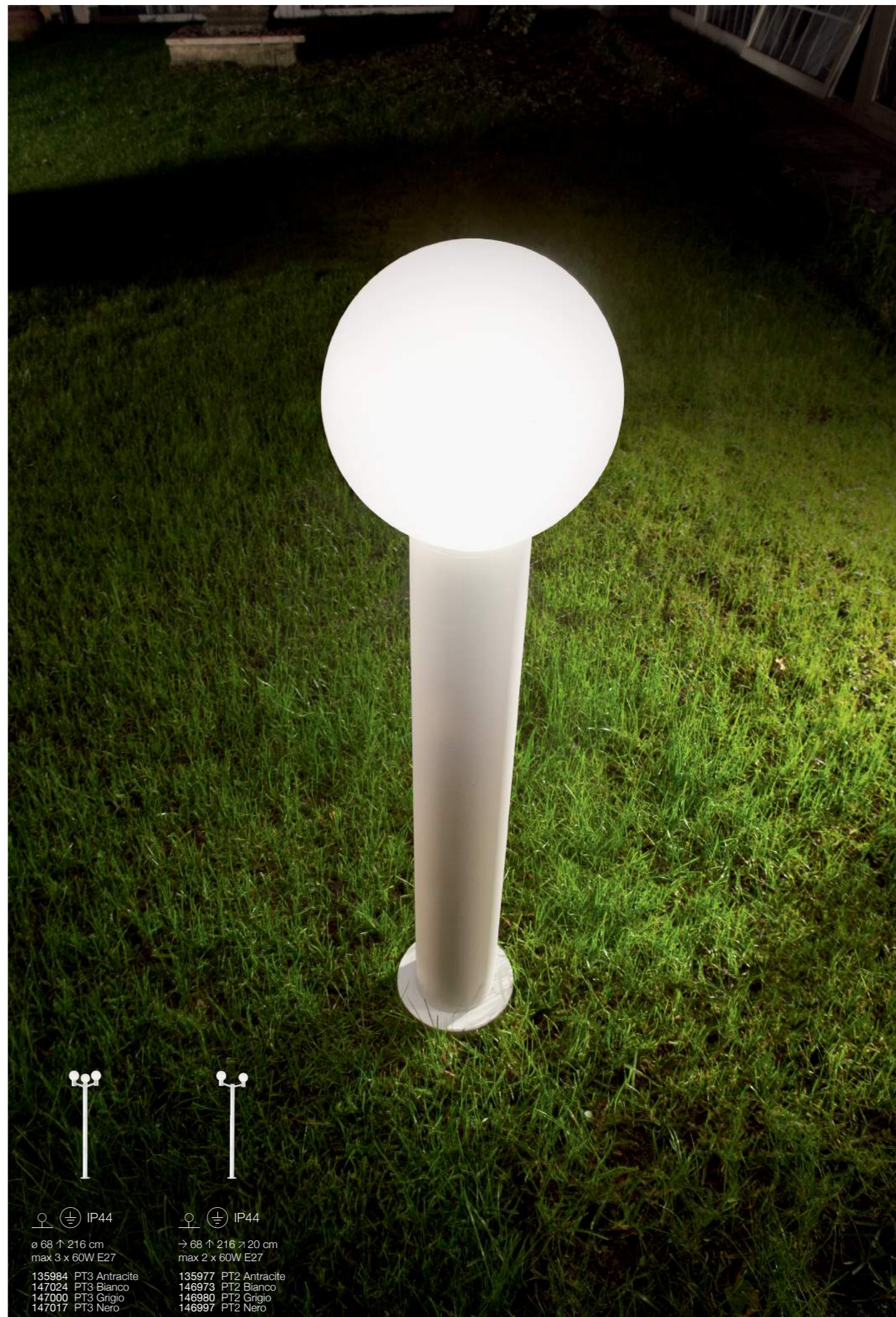

IP44

ø 68 ↑ 216 cm
max 3 x 60W E27

135984 PT3 Antracite
147024 PT3 Bianco
147000 PT3 Grigio
147017 PT3 Nero



IP44

→ 68 ↑ 216 ↗ 20 cm
max 2 x 60W E27

135977 PT2 Antracite
146973 PT2 Bianco
146980 PT2 Grigio
146997 PT2 Nero

Clio

Montatura in alluminio pressofuso e tornito, rifinito con vernici a polveri. Diffusore in materiale plastico bianco opaco.

Turned die-cast aluminium frame, finished with matt powder coating. Plastic diffuser with matt white finish. / Monture en métal coulé sous pression et travaillé sur tour, finie avec vernis à poudre. Diffuseur en matière plastique blanc mat. / Gestell aus gedrehtem Aluminiumspritzguss, pulverlackbeschichtet. Lichtverteiler aus Plastik weiß matt. / Armazón en aluminio fundido y torneado, acabado con barnices a polvos. Difusor en material plástico blanco opaco. / Арматура из литого выточенного алюминия порошковой окраски. Рассеиватель из матового белого пластикового материала.





- Antracite
- Bianco
- Grigio
- Nero





 IP44
 ø 20 ↑ 35,5/119,5 cm
 max 1 x 60W E27
 149905 SP1 Antracite
 149912 SP1 Bianco
 149929 SP1 Grigio
 149936 SP1 Nero





 IP44
 ø 20 ↑ 23 cm
 max 1 x 60W E27
 149875 PL1 Antracite
 149523 PL1 Bianco
 149882 PL1 Grigio
 149899 PL1 Nero



 IP44
 → 20 ↑ 28,5 ↗ 27,5 cm
 max 1 x 60W E27
 146607 AP1 Antracite
 146621 AP1 Bianco
 146638 AP1 Grigio
 146614 AP1 Nero



 IP44
 ø 20 ↑ 79 cm
 max 1 x 60W E27
 135366 PT1 H60 Antracite
 135380 PT1 H60 Bianco
 135373 PT1 H60 Grigio
 135397 PT1 H60 Nero



 IP44
 ø 20 ↑ 59 cm
 max 1 x 60W E27
 147031 PT1 H40 Antracite
 147048 PT1 H40 Bianco
 147055 PT1 H40 Grigio
 147062 PT1 H40 Nero



 IP44
 ø 68 ↑ 216 cm
 max 3 x 60W E27
 147123 PT3 Antracite
 147130 PT3 Bianco
 147147 PT3 Grigio
 147154 PT3 Nero



 IP44
 → 68 ↑ 216 ↗ 20 cm
 max 2 x 60W E27
 147079 PT2 Antracite
 147086 PT2 Bianco
 147116 PT2 Grigio
 147109 PT2 Nero

Sound

Montatura in alluminio pressofuso e tornito, rifinito con vernici a polveri. Diffusore in materiale plastico bianco opaco.

Turned die-cast aluminium frame, finished with matt powder coating. Plastic diffuser with matt white finish. / Monture en métal coulé sous pression et travaillé sur tour, finie avec vernis à poudre. Diffuseur en matière plastique blanc mat. / Gestell aus gedrehtem Aluminiumspritzguss, pulverlackbeschichtet. Lichtverteiler aus Plastik weiß matt. / Armazón en aluminio fundido y torneado, acabado con barnices a polvos. Difusor en material plástico blanco opaco. / Арматура из литого выточенного алюминия порошковой окраски. Рассеиватель из матового белого пластикового материала.



- Antracite
- Bianco
- Grigio
- Nero



ø 30 ↑ 35/120,5 cm
max 1 x 60W E27
150048 SP1 Antracite
150055 SP1 Bianco
150062 SP1 Grigio
150079 SP1 Nero



ø 30 ↑ 24 cm
max 1 x 60W E27
150017 PL1 Antracite
150024 PL1 Bianco
144191 PL1 Grigio
150031 PL1 Nero



→ 30 ↑ 29,5 ↗ 32,5 cm
max 1 x 60W E27
146553 AP1 Antracite
146560 AP1 Bianco
136226 AP1 Grigio
146546 AP1 Nero



ø 30 ↑ 80 cm
max 1 x 60W E27
146836 PT1 H60 Antracite
146843 PT1 H60 Bianco
136189 PT1 H60 Grigio
146850 PT1 H60 Nero



ø 30 ↑ 60 cm
max 1 x 60W E27
146812 PT1 H40 Antracite
146805 PT1 H40 Bianco
136196 PT1 H40 Grigio
146829 PT1 H40 Nero



ø 78 ↑ 217 cm
max 3 x 60W E27
146898 PT3 Antracite
146904 PT3 Bianco
136219 PT3 Grigio
147437 PT3 Nero



→ 78 ↑ 217 ↗ 20 cm
max 2 x 60W E27
146874 PT2 Antracite
146867 PT2 Bianco
136202 PT2 Grigio
146881 PT2 Nero

Concerto

Montatura in alluminio pressofuso e tornito, rifinito con vernici a polveri. Diffusore in materiale plastico bianco opaco.

Turned die-cast aluminium frame, finished with matt powder coating. Plastic diffuser with matt white finish. / Monture en métal coulé sous pression et travaillé sur tour, finie avec vernis à poudre. Diffuseur en matière plastique blanc mat. / Gestell aus gedrehtem Aluminiumspritzguss, pulverlackbeschichtet. Lichtverteiler aus Plastik weiß matt. / Armazón en aluminio fundido y torneado, acabado con barnices a polvos. Difusor en material plástico blanco opaco. / Арматура из литого выточенного алюминия порошковой окраски. Рассеиватель из матового белого пластикового материала.



- Antracite
- Bianco
- Grigio
- Nero



ø 23 ↑ 98,5/124 cm
max 1 x 60W E27
149974 SP1 Antracite
149981 SP1 Bianco
149998 SP1 Grigio
150000 SP1 Nero



ø 23 ↑ 27 cm
max 1 x 60W E27
149943 PL1 Antracite
149950 PL1 Bianco
149967 PL1 Grigio
144214 PL1 Nero



→ 23 ↑ 93 ↑ 29 cm
max 1 x 60W E27
146669 AP1 Antracite
146645 AP1 Bianco
146652 AP1 Grigio
136127 AP1 Nero



ø 23 ↑ 83,5 cm
max 1 x 60W E27
147260 PT1 H60 Antracite
147277 PT1 H60 Bianco
147284 PT1 H60 Grigio
136097 PT1 H60 Nero



ø 23 ↑ 62,5 cm
max 1 x 60W E27
147253 PT1 H40 Antracite
147239 PT1 H40 Bianco
147246 PT1 H40 Grigio
136080 PT1 H40 Nero



ø 70 ↑ 220,5 cm
max 3 x 60W E27
147192 PT3 Antracite
147178 PT3 Bianco
147185 PT3 Grigio
136110 PT3 Nero



→ 70 ↑ 220,5 ↑ 20 cm
max 2 x 60W E27
147208 PT2 Antracite
147215 PT2 Bianco
147222 PT2 Grigio
136103 PT2 Nero



Cima

Corpo luce interamente in alluminio pressofuso. Con finitura nero e oro. Diffusore in acrilico trasparente.

Die-cast aluminium frame. Black and gold finish. Transparent acrylic diffuser. / Corps en aluminium coulé sous pression, avec finition en noir et or. Diffuseur acrylique transparent. / Lichtkörper aus Aluminiumspritzguss. Ausführung schwarz-gold. Lichtverteiler aus transparentem Acryl. / Elemento de iluminación totalmente de aluminio fundido a presión. Acabado en negro. Difusor en acrílico transparente. / Корпус полностью из литого алюминия. Доступен в чёрно-золотой отделке. Рассеиватель из прозрачного акрила.



⊙ ⊕ IP43
→ 25 ↑ 46 ⇨ 40 cm
max 1 x 60W E27
024134 AP1



⊙ ⊕ IP43
∅ 83 ↑ 216 cm
max 2 x 60W E27
024097 PT2





Anna

Corpo luce in resina ad alte prestazioni: inattaccabile dalla corrosione, colori stabilizzati da trattamento UV., resistente a sbalzi termici da -60° C a + 90° C. Diffusore in metacrilato antingiallimento.

High performance resin body: resistant to corrosion, colours stabilized during UV rays treatment, thermal shock resistance from -60° to +90°C. Methacrylate non-yellowing diffuser. / Corps lumineux en résine de haute prestation: inattaquable par la corrosion, couleurs stabilisés avec traitement UV., résistant aux écarts de température de 60°C à + 90°C. Diffuseur en méthacrylate anti jaunissement. / Lichtkörper aus bestleistendem Harz: Korrosionsunangrifflich, Farben durch UV-Behandlung stabilisiert, Thermosprungfest von -60° C bis + 90° C. Lichtverteiler aus Methacrylat vergilbungsfest. / Cuerpo de luz en resina con altas prestaciones: inatacable corrosión, colores estables por tratamiento U.V., resistente a cambios térmicos de -60°C a +90° C. Difusores en metacrilato anti amarilleo. / Корпус света из смеси высокоэффективных смол: коррозионностойкий, цвета защищены от ультрафиолетового света, устойчивый к перепадам температур от -60° до + 90°. Рассеиватель из метилметакрилата, анти-пожелтение.



IP44

ø 22 ↑ 45/80 cm
max 1 x 60W E27

120485 SP1 Bianco
101507 SP1 Nero



IP44

→ 22 ↑ 45 ↑ 27,5 cm
max 1 x 60W E27

120423 AP1 Big Bianco
101491 AP1 Big Nero



IP44

→ 22 ↑ 35 ↑ 13 cm
max 1 x 60W E27

120430 AP1 Small Bianco
101552 AP1 Small Nero



IP44

ø 22 ↑ 110 cm
max 1 x 60W E27

120454 PT1 Small Bianco
101514 PT1 Small Nero





Eclisse

Corpo luce in fusione di alluminio rifinito con vernice a polveri. Diffusore in materiale acrilico trasparente, satinato sulla parte bassa.

Die-cast aluminium body finished with powder coating. Transparent acrylic diffuser with glazed bottom. / Corps lumineux en fusion d'aluminium fini avec vernis à poudre. Diffuseur de matière acrylique transparente, mat sur la partie en bas. / Lichtkörper aus Aluminiumguss pulverlackiert. Lichtverteiler aus transparentem Acrylmaterial, unten satiniert. / Cuerpo de luz en fusión de aluminio acabado con barniz opaca a polvos. Difusor en material acrílico transparente, satinado en la parte baja. / Корпус света из литого алюминия порошковой окраски. Рассеиватель из акрилового прозрачного материала, матового в нижней части.



Nero



⊙ ⊕ IP44

⇒ 8 ↑ 25 ↑ 14 cm
max 1 x 3W G9

135410 AP1 Bianco
135427 AP1 Nero

⊙ ⊕ IP44

∅ 9 ↑ 80 cm
max 1 x 15W G9

135519 PT1 Big Bianco
135533 PT1 Big Nero

⊙ ⊕ IP44

∅ 9 ↑ 60 cm
max 1 x 15W G9

135441 PT1 Small Bianco
135489 PT1 Small Nero



Bianco



Nero

Marte

Corpo luce in alluminio verniciato a polveri.
Diffusore bianco in materiale acrilico.

Powder coated aluminum body. White acrylic diffuser.
/ Corps lumineux en aluminium verni à poudres.
Diffuseur blanc en matériel acrylique. / Lichtkörper aus
Aluminiumspritzguss pulverlackbeschichtet. Lichtverteiler
weiß aus Acrylmaterial. / Cuerpo de luz en aluminio
barnizado a polvos. Difusor blanco en material acrílico.
/ Корпус света из алюминия порошковой окраски.
Рассеиватель белый из акрилового материала.



Antracite



Bianco



Grigio



⊙ ⊕ IP44

→ 9 ↑ 33 ↗ 18,5 cm
max 1 x 60W E27

135854 AP1 Antracite
135861 AP1 Bianco
135878 AP1 Grigio
135885 AP1 Nero

⊙ ⊕ IP44

→ 14 ↑ 80,5 ↗ 14 cm
max 1 x 60W E27

092225 PT1 Antracite
135892 PT1 Bianco
092249 PT1 Grigio
092232 PT1 Nero



Tronco

Corpo luce in alluminio pressofuso rifinito in vernice disponibile nei colori bianco, grigio, antracite o nero. Diffusore in vetro pirex con elementi interni in alluminio.

Die-cast aluminum body finished with white, grey, anthracite or black paint. Pyrex diffuser with aluminum details inside. / Corps lumineux en aluminium coulé sous pression fini avec vernis disponible en couleurs blanc, gris, anthracite ou noir. Diffuseur en verre pyrex avec éléments internes en aluminium. / Lichtkörper aus Aluminiumspritzguß lackiert, in weiß, grau, anthrazit oder schwarz erhältlich. Lichtverteiler aus Pyrexglas mit inneren Elementen aus Aluminium. / Cuerpo de luz en aluminio fundido acabado con barniz disponible en los colores blanco, gris, antracita o negro. Difusor en vidrio pirex con elementos internos en aluminio. / Корпус света из литого алюминия и доступен в белом, сером, антрацитовом и черном цветах. Рассеиватель из стекла пирекс с внутренними элементами из алюминия.



Bianco

Antracite

Nero

Grigio



Gas

Corpo luce in alluminio pressofuso verniciato a polveri. Diffusore in vetro temperato trasparente sabbiato.

Powder coated die-cast aluminum body. Tempered and sandblasted clear glass diffuser. / Corps lumineux en aluminium moulé sous pression et verni à poudre. Diffuseur en verre transparent trempé et sablé. / Lichtkörper aus Aluminiumspritzguss pulverlackbeschichtet. Lichtverteiler aus gehärtetem Glas transparent sandgestrahlt. / Cuerpo de luz en aluminio fundido barnizado a polvos. Difusor en vidrio temperado transparente arenado. / Корпус света из литого алюминия порошковой окраски. Рассеиватель из прозрачного закаленного стекла пескоструйной обработки.



Antracite



Bianco



Nero



⊕ ⊖ IP43

→ 11,5 ↑ 9,5 ↗ 15 cm
max 1 x 28W GU10

091525 AP1 Antracite
091518 AP1 Bianco
020228 AP1 Nero



⊕ ⊖ IP43

→ 80,5 ↑ 80 ↗ 11,5 cm
max 2 x 35W GU10

139500 PT2 Antracite
139524 PT2 Bianco
139531 PT2 Nero



⊕ ⊖ IP43

→ 20,5 ↑ 80 ↗ 11,5 cm
max 1 x 35W GU10

139470 PT1 Antracite
139487 PT1 Bianco
139494 PT1 Nero

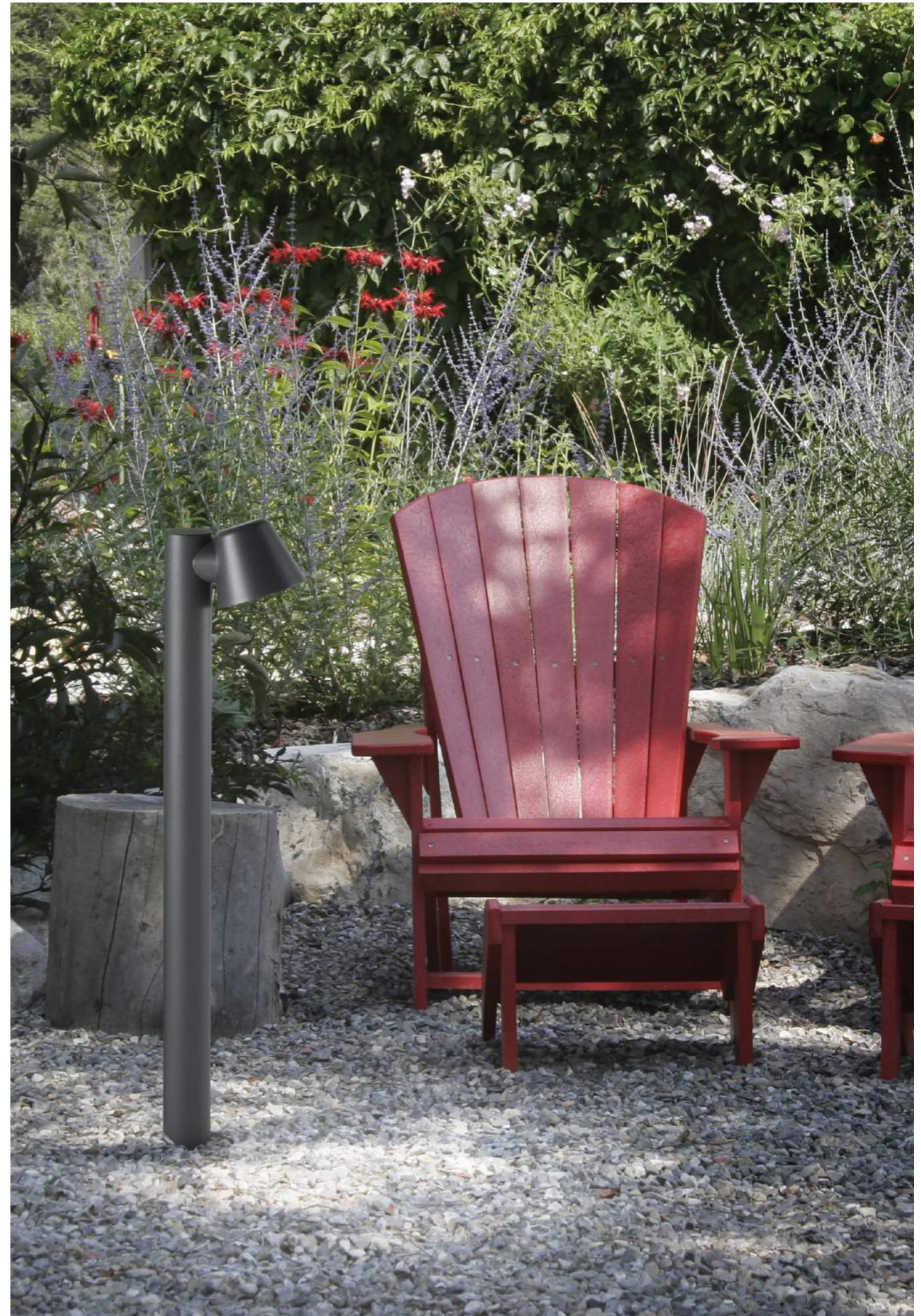

Green

Corpo luce in fusione di alluminio verniciato a polveri. Diffusore in policarbonato bianco.

Cast aluminium reflecting body with powder coating. Polycarbonate white diffuser. / Corps lumineux en fusion d'aluminium verni à poudres. Diffuseur en polycarbonate blanc. / Lichtkörper aus Aluminiumguss pulverlackiert. Lichtverteiler aus Polycarbonat weiß. / Cuerpo de luz en fusión de aluminio barnizado a polvos. Difusor en policarbonato blanco. / Корпус света из литого алюминия порошковой окраски. Рассеиватель из белого поликарбоната.



Grigio

Nero

Bianco

Antracite



⊕ ⊖ IP44

ø 20 ↑ 80 cm
max 1 x 60W E27

135779 PT1 Big Antracite
135786 PT1 Big Bianco
135830 PT1 Big Grigio
135847 PT1 Big Nero

⊕ ⊖ IP44

ø 20 ↑ 60 cm
max 1 x 60W E27

139555 PT1 Small Antracite
139579 PT1 Small Bianco
135793 PT1 Small Grigio
135809 PT1 Small Nero



Midras

Corpo luce in alluminio tornito, rifinito in vernice opaca disponibile nei colori antracite, bianco, grigio o nero. Diffusore in vetro temperato.

Turned aluminium body with matt paint finish available in anthracite, white, grey or black. Tempered glass diffuser. / Corps lumineux en aluminium travaillé sur le tour, fini en vernis mat disponible en couleurs anthracite, blanc, gris ou noir. Diffuseur en verre trempé. / Lichtkörper aus Aluminium gedreht, matt lackiert. In anthrazit, weiß, grau oder schwarz erhältlich. Lichtverteiler aus gehärtetem Glas. / Cuerpo de luz en aluminio torneado acabado en barniz opaca, disponible en los colores antracita, blanco, gris o negro. Difusor en cristal temperado. / Корпус света из выточенного алюминия, покрыт матовой краской и доступен в антрацитовом, белом, сером и черном цветах. Рассеиватель из tempered glass.



Antracite

Bianco

Grigio



Nero

⊕ ⊖ IP44

ø 15,5 x 180 cm
max 1 x 15W G9

113838 PT1 Antracite
113814 PT1 Bianco
113845 PT1 Grigio
113821 PT1 Nero



Sirio

Corpo luce in alluminio verniciato a polveri.
Diffusore in vetro pirex trasparente.

Powder coated aluminum body. Clear Pyrex glass
diffuser. / Corps lumineux en aluminium verni à poudres.
Diffuseur en verre pyrex transparent. / Lichtkörper
aus Aluminium pulverlackiert. Lichtverteiler aus
transparentem Pyrexglas. / Cuerpo de luz en aluminio
barnizado a polvos. Difusor en vidrio pirex transparente.
/ Корпус света из алюминия порошковой окраски.
Рассеиватель из прозрачного стекла pyrex.



Antracite

Bianco

Nero



⊕ ⊖ IP44

→ 10 ↑ 80 ↗ 16 cm
max 2 x 15W G9

115061 PT2 Big Antracite
115085 PT2 Big Bianco
115108 PT2 Big Nero

⊕ ⊖ IP44

→ 10 ↑ 60 ↗ 15 cm
max 2 x 15W G9

115078 PT2 Small Antracite
115092 PT2 Small Bianco
115115 PT2 Small Nero



Edo Outdoor

Montatura in fusione d'alluminio verniciato a polveri in vari colori. Diffusore in policarbonato bianco.

Die-cast aluminium structure finished with colour powder coating. White polycarbonate diffuser. / Structure en fusion d'aluminium vernie à poudres en différentes couleurs. Diffuseur en polycarbonate blanc. / Gestell aus Aluminiumguss, in verschiedenen Farben pulverlackiert. Lichtverteiler aus Polycarbonat weiß. / Armazón en fusión de aluminio barnizado a polvos en varios colores. Difusor en policarbonato blanco. / Арматура из литого алюминия порошковой окраски разных цветов. Рассеиватель из белого поликарбоната.



Nero



Antracite



⊙ ⊕ IP44

∅ 15,5 ↑ 80 cm
max 1 x 15W GX53

138510 PT1 Round Antracite
138755 PT1 Round Bianco
138503 PT1 Round Nero



⊙ ⊕ IP44

⇒ 15 ↑ 79 ↗ 15 cm
max 1 x 15W GX53

135762 PT1 Square Antracite
142999 PT1 Square Bianco
143002 PT1 Square Nero



Bianco

Pulsar

Montatura in fusione d'alluminio verniciato a polveri in vari colori. Diffusore in policarbonato bianco.

Cast aluminium body with powder coating in different colours. White polycarbonate diffuser. / Structure en fusion d'aluminium verni à poudres en différentes couleurs. Diffuseur en polycarbonate blanc. / Gestell aus Aluminiumguss in verschiedenen Farben pulverlackiert. Lichtverteiler aus Polycarbonat weiß. / Armazón en fusión de aluminio barnizado a polvos en varios colores. Difusor en policarbonato blanco. / Арматура из литого алюминия порошковой окраски разных цветов. Рассеиватель из белого поликарбоната.



♀ ♂ P44

⇒ 10,5 ↑ 80 ↗ 10 cm
max 1 x 42W E27

135908 PT1 Antracite
135915 PT1 Bianco
135922 PT1 Grigio
135939 PT1 Nero



Venus

Corpo luce in lamina d'acciaio disponibile con finitura spazzolata, antracite, bianco o nero. Elemento diffusore superiore in acrilico satinato.

Steel foil body available with brushed, anthracite, white or black finish. Satin acrylic top-diffuser. / Corp lumineux en feuille d'acier disponible avec finition brossée, antracite, blanche ou noire. Diffuseur supérieur en acrylique mat. / Lichtkörper aus Stahlfolie gebürstet, anthrazit, weiß oder schwarz erhältlich. Oberer Lichtverteiler in Acryl satin. / Cuerpo de luz en lámina de acero disponible con acabados cepillados, antracita, blanco o negro. Elemento difusor superior en acrílico satinado. / Корпус света стальной пластины, доступен в антрацитовом, белом или черном цвете. Верхний элемент рассеивателя из матового акрила.

 Lampadine GU10 7W Ceramica incluse.

 Sorgente luminosa LED a luce calda, 25.000 h di durata.



Antracite Bianco Nero



ø 12 ↑ 80 cm
max 1 x 15W GU10

089775 PT1 Big Acciaio
106175 PT1 Big Antracite
118949 PT1 Big Bianco
106151 PT1 Big Nero



ø 12 ↑ 60 cm
max 1 x 15W GU10

010892 PT1 Small Acciaio
106182 PT1 Small Antracite
118956 PT1 Small Bianco
106168 PT1 Small Nero



Acciaio

Mercurio

Corpo luce in alluminio verniciato a polveri.
Diffusore in vetro pirex trasparente.

Powder coated aluminum body. Clear Pyrex glass
diffuser. / Corps lumineux en aluminium verni à poudres.
Diffuseur en verre pyrex transparent. / Lichtkörper aus
Aluminium pulverlackiert. Lichtverteiler aus Pyrexglas
transparent. / Cuerpo de luz en aluminio barnizado
a polvos. Difusor en vidrio pirex transparente. /
Корпус света из алюминия порошковой окраски.
Рассеиватель из прозрачного стекла pyrex.



⊕ ⊖ IP44

⇒ 5 ↑ 60 ↓ 10 cm
max 1 x 15W G9

114347 PT1 Antracite
114323 PT1 Bianco
114354 PT1 Grigio
114330 PT1 Nero



Polaris

Corpo luce in alluminio verniciato a polveri.
Diffusore in vetro pirex trasparente.

Powder coated aluminum body. Clear Pyrex glass
diffuser. / Corps lumineux en aluminium verni à poudres.
Diffuseur en verre pyrex transparent. / Lichtkörper
aus Aluminium pulverlackiert. Lichtverteiler aus
transparentem Pyrexglas. / Cuerpo de luz en aluminio
barnizado a polvos. Difusor en vidrio pirex transparente.
/ Корпус света из алюминия порошковой окраски.
Рассеиватель из прозрачного стекла pyrex.



⊕ ⊖ P44

∅ 8,5 ↑ 60,5 cm
max 1 x 15W G9

115122 PT1 Antracite
115139 PT1 Bianco
113500 PT1 Grigio
115221 PT1 Nero



Vega

Corpo luce in alluminio con finitura in vernice opaca a polveri. Diffusore in vetro temperato trasparente.

Aluminium body with matt powder coating. Clear tempered glass diffuser. / Corps lumineux en aluminium avec finition en vernis mat à poudres. Diffuseur en verre trempé transparent. / Lichtkörper aus Aluminium matt pulverlackiert. Lichtverteiler aus transparentem gehärtetem Glas. / Cuerpo de luz en aluminio con acabado en barniz blanca a polvos. Difusor en vidrio temperado transparente. / Корпус света из алюминия матовой порошковой окраски. Рассеиватель из прозрачного терпированного стекла.



⊕ ⊖ P44

→ 15 ↑ 80 ↗ 5 cm
max 1 x 15W G9

136028 PT1 Antracite
136035 PT1 Bianco
136042 PT1 Grigio
136059 PT1 Nero



Acqua

Corpo luce in alluminio tornito rifinito in vernice opaca, disponibile nei colori antracite, bianco, grigio o nero. Diffusore in vetro temperato.

Turned aluminium reflecting body with matt paint, available colours: anthracite, white, grey and black. Tempered glass diffuser. / Corps lumineux en aluminium travaillé sur le tour et fini en vernis mat, disponible en couleurs anthracite, blanc, gris ou noir. Diffuseur en verre trempé. / Lichtkörper aus Aluminium gedreht, matt lackiert. In anthrazit, weiß, grau oder schwarz erhältlich. Lichtverteiler aus gehärtetem Glas. / Cuerpo de luz en aluminio torneado acabado en barniz opaca, disponible en los colores antracita, blanco, gris o negro. Difusor en cristal temperado. / Корпус света из выточенного алюминия окрашенного матовой краской, доступна в антраците, белом, сером и черном цветах. Рассеиватель из темперированного стекла.



⊕ ⊖ P44

∅ 13,5 1' 60 cm
max 1 x 15W G9
135205 PT1 Antracite
135212 PT1 Bianco
135229 PT1 Grigio
135236 PT1 Nero



Bamboo

Corpo luce in alluminio pressofuso rifinito con vernice a polveri. Diffusore in acrilico trasparente con interno sabbato.

Die-cast aluminum body light with powder coat finish. Clear acrylic diffuser sandblasted inside. / Corps lumineux en aluminium moulé sous pression fini en vernis à poudre. Diffuseur en acrylique transparent sablé à l'intérieur. / Lichtkörper aus Aluminiumspritzguß pulverlackbeschichtet. Lichtverteiler aus transparentem Acrylmaterial, innen sandgestrahlt. / Cuerpo de luz en aluminio fundido acabado con barniz a polvos. Difusor en acrilico transparente con interno arenado. / Корпус света из литого алюминия порошковой окраски. Рассеиватель из прозрачного акрила пескоструйной обработки внутри.



Antracite

Bianco

Nero



⊕ ⊖ IP44

ø 13 x 81,5 cm
max 1 x 15W G9
102894 PT1 Antracite
108230 PT1 Bianco
059884 PT1 Nero





Zenith

Montatura in fusione d'alluminio verniciata a polveri. Corpo luce posizionabile. Diffusore in materiale plastico.

Powder coated die-cast aluminum frame. Adjustable reflecting body. Plastic diffuser. / Monture en fusion d'aluminium vernie à poudre. Corps lumineux positionnable. Diffuseur en matière plastique. / Gestell aus Aluminiumguß pulverlackiert. Lichtkörper einstellbar. Lichtverteiler aus Plastikmaterial. / Armazón en aluminio fundido barnizada a polvos. Cuerpo de luz orientable. Difusor en material plastico. / Рассеиватель из пластмассового материала. Снабжен основой для стены или штырем для земли.

Lampadine GU10 7W Ceramica incluse.

Sorgente luminosa LED a luce calda, 25.000 h di durata.



ø 12 ↑ 17 cm max 1 x 11W GU10	ø 13,5 ↑ 80 cm max 1 x 11W GU10	ø 13,5 ↑ 60 cm max 1 x 11W GU10	ø 12 ↑ 30 cm max 1 x 11W GU10
108353 AP1 Antracite 108261 AP1 Bianco 108360 AP1 Nero	124469 PT1 Big Antracite 124445 PT1 Big Bianco 124476 PT1 Big Nero	124421 PT1 Medium Antracite 124452 PT1 Medium Bianco 124438 PT1 Medium Nero	108407 PT1 Small Antracite 108384 PT1 Small Bianco 108391 PT1 Small Nero



Bianco



Minitommy

Corpo luce e diffusore in resina ad alte prestazioni: inattaccabile dalla corrosione sia di agenti atmosferici che di fertilizzanti chimici, colori stabilizzati da trattamento U.V., resistente a sbalzi termici da -60° C a + 90° C. Diffusore direzionabile.

High performance resin body and diffuser: resistant to corrosion caused by both atmospheric agents and chemical fertilizers, colours stabilized during UV rays treatment, thermal shock resistance from -60° to +90°C. Adjustable diffuser. / Corps lumineux et diffuseur en résine de haute prestation: inattaquable par la corrosion, soit des agents atmosphériques que des fertilisants chimiques, couleurs stabilisés avec traitement U.V., résistant aux écarts de température de 60°C à + 90°C. Diffuseur positionnable. / Lichtkörper und Lichtverteiler aus bestleistendem Harz: Korrosionsunangrifflich von atmosphärischen Einwirkungen und von chemischen Düngern, Farben durch UV-Behandlung stabilisiert, Thermosprungfest von -60° C bis + 90° C. Lichtverteiler einstellbar. / Cuerpo de luz y difusor en resina con altas prestaciones: inatacable en la corrosión sea por agentes atmosféricos que por fertilizantes químicos; colores estables por tratamiento U.V., resistente a cambios térmicos de -60°C a +90° C. Difusor orientable. / Корпус света и рассеиватель из смеси высокоэффективных смол: коррозионноустойчивый как от атмосферных факторов, так и химических элементов, цвета защищены от ультрафиолетового света, устойчивый к перепадам температур от -60° до + 90°. Рассеиватель направляемый.





Nero

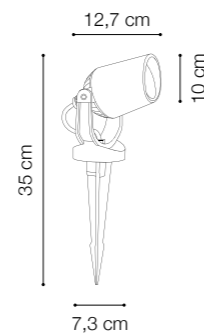
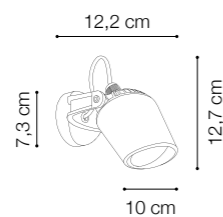

 Lampadine GU10 4,5W LED incluse.

 Sorgente luminosa LED a luce fredda, 25.000 h di durata.



  
max 1 x 4,5W GU10
096483 AP1 Bianco
096476 AP1 Nero



  
max 1 x 4,5W GU10
120218 PT1 Bianco
120201 PT1 Nero



Tommy

Corpo luce e diffusore in resina ad alte prestazioni: inattaccabile dalla corrosione sia di agenti atmosferici sia di fertilizzanti chimici; colori stabilizzati da trattamento U.V.. Resistente a sbalzi termici da -60° C a + 90° C. Diffusore direzionabile.

High performance resin body and diffuser: resistant to corrosion caused by atmospheric agents; colours stabilized during U.V. treatment; thermal shock resistance from -60°C to + 90°C. Adjustable diffuser. / Corps lumineux et diffuseur en résine à haute performance: inattaquable par la corrosion soit des agents atmosphériques que des engrais chimiques. Couleurs stabilisés avec traitement U.V. résistant aux écarts de température de -60° jusqu'à +90°. Diffuseur orientable. / Lichtkörper und Lichtverteiler aus bestleistendem Harz: Korrosionsunangrifflich von atmosphärischen Einwirkungen und von chemischen Düngern; Farben durch UV-Behandlung stabilisiert. Thermosprungfest von -60° C bis +90° C. Lichtverteiler einstellbar. / Cuerpo de luz y difusor en resina con altas prestaciones: inatacable en la corrosión de agentes atmosféricos, colores estables con tratamiento U.V. Resistente a cambios térmicos desde -60° C a + 90° C. Difusor orientable. / Корпус света и рассеиватель из смеси высокоэффективных смол: коррозионностойкий как от атмосферных факторов, так и химических элементов, цвета защищены от ультрафиолетового света, устойчивый к перепадам температур от -60° до +90° C. Рассеиватель направляемый.

 Lampadine GX53 7W LED incluse.

 Sorgente luminosa LED a luce fredda, 25.000 h di durata.

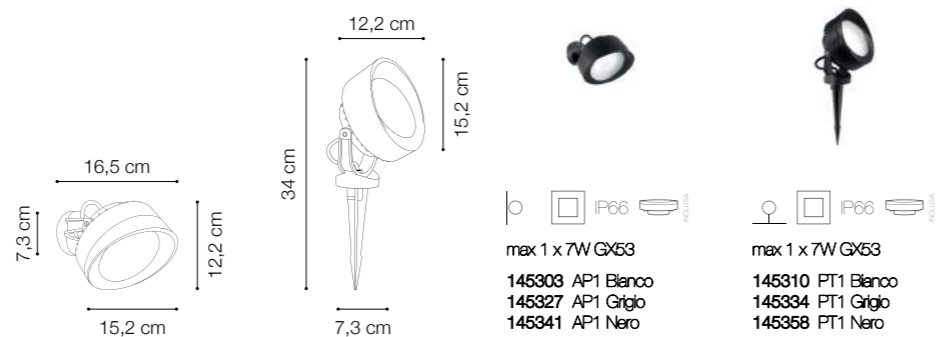

Inside

Montatura in fusione d'alluminio verniciato a polveri.
Corpo luce posizionabile. Diffusore in vetro pirex trasparente. Dotato di lancia da interrare.

Powder coated cast aluminum frame. Adjustable body.
Clear Pyrex glass diffuser. Provided with peg to plant in the ground. / Monture en fusion d'aluminium vernie à poudre. Corps lumineux positionnable. Diffuseur en verre pirex transparent. Équipé de lance à interrer. / Fuß aus Aluminiumguß pulverlackiert. Lichtkörper einstellbar. Lichtverteiler aus Pyrexglas transparent. Mit Speerfuß zur Eingrabung versehen. / Armazón en fusión de aluminio barnizado a polvos. Cuerpo de luz posicionable. Difusor en vidrio pirex transparente. Dotado de lanza para enterrar. / Арматура из литого алюминия порошковой окраски. Корпус света регулируемый. Рассеиватель из прозрачного стекла pyrex. Снабжен штырем для земли.

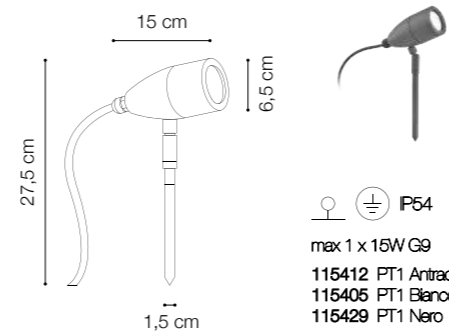

Terra

Montatura in fusione d'alluminio verniciata. Corpo luce posizionabile. Diffusore in vetro pirex trasparente. Disponibile con base a muro o a lancia da interrare.

Cast aluminium painted frame. Adjustable body. Transparent pyrex glass diffuser. Available as wall lamp or with plantable base. / Monture en aluminium coulé sous pression et verni. Corps lumineux réglable. Diffuseur en verre pyrex transparent. Disponible comme applique ou avec lance à enterrer. / Gestell aus Aluguß lackiert. Lichtkörper einstellbar. Lichtverteiler aus transparentem Pyrex-Glas. Mit Wandbefestigung oder Speerfuß zur Eingrabung erhältlich. / Armazón de aluminio fundido pintado. Elemento de iluminación posicionable. Difusor de vidrio pirex transparente. Disponible con base de pared o con lanza de enterrar. / Арматура из литого окрашенного алюминия. Корпус регулируемый. Рассеиватель из прозрачного стекла пирекс. Доступен с креплением к стене или со штыком для наземного крепления.

 Lampadine GU10 28W incluse nei modelli: AP1 Small e PT1 Small.



Bianco



Antracite

			
   IP65	   IP65 	  IP65	  IP65 
max 1 x 60W E27	max 1 x 35W GU10	max 1 x 60W E27	max 1 x 35W GU10
046167 AP1 Big Antracite 106212 AP1 Big Bianco	046181 AP1 Small Antracite 106199 AP1 Small Bianco	033044 PT1 Big Antracite 106229 PT1 Big Bianco	033037 PT1 Small Antracite 106205 PT1 Small Bianco

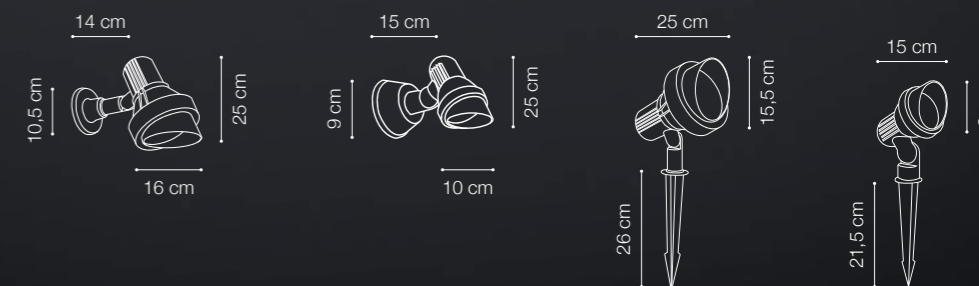

Krypton

Corpo luce in acciaio spazzolato. LED integrati. Diffusore posizionabile per l'orientamento del flusso luminoso.

Brushed steel body. Integrated LED sources. Adjustable diffuser allows the regulation of the light spread. / Corps lumineux en acier brossé. LED intégrés. Diffuseur positionnable pour l'orientation du flux lumineux. / Lichtkörper aus Stahl gebürstet. LED integriert. Lichtverteiler zur Orientierung des Lichtstrahls einstellbar. / Cuerpo de luz en acero cepillado. LED integrados. Difusores posicionables para la orientación del flujo luminoso. / Корпус света из матового сталя. ЛЕД встроенный. Рассеиватель регулируемый по направлению потока света.

LED Sorgente luminosa LED a luce calda, 15.000 h di durata.

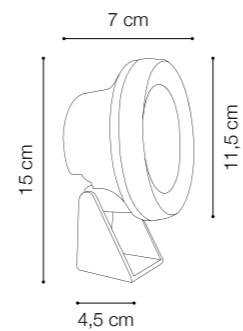



**WALL
AND CEILING**

Xeno

Corpo luce in alluminio rifinito con vernice opaca a polveri. Diffusori orientabili con vetro temperato trasparente.

Aluminium base with matt powder coating. Tempered clear glass adjustable diffusers. / Corps lumineux en aluminium fini en vernis mat à poudres. Diffuseurs orientables avec verre trempé transparent. / Lichtkörper aus Aluminium matt pulverlackiert. Einstellbare Lichtverteiler aus transparentem, gehärtetem Glas. / Cuerpo de luz en aluminio acabado con barniz opaca a polvos. Difusor orientable con vidrio temperado transparente. / Корпус света из алюминия матовой порошковой окраски. Рассеиватели вращаемые с прозрачным терпированным стеклом.



⊕ ⊖ IP44

→ 9 ↑ 24 ↗ 14/16 cm
max 2 x 28W GU10

129495 AP2 Bianco
129518 AP2 Grigio
129501 AP2 Nero



⊕ ⊖ IP44

→ 9 ↑ 11 ↗ 11,5/13,5 cm
max 1 x 28W GU10

129488 AP1 Bianco
129471 AP1 Grigio
129464 AP1 Nero



Zeus

Corpo luce in alluminio grezzo spazzolato. Diffusori orientabili con vetro temperato trasparente e acidato.

Brushed raw aluminium body. Adjustable clear tempered acid-etched glass diffusers. / Corps lumineux en aluminium brossé brut. Diffuseurs orientables avec verre trempé transparent et traité à l'acide. / Lichtkörper aus Rohaluminium gebürstet. Einstellbare Lichtverteiler mit transparentem gehärtetem und geätzttem Glas. / Cuerpo de luz en aluminio tosco cepillado. Difusor orientable con vidrio temperado transparente y al ácido. / Корпус света из необработанного зачищенного алюминия. Рассеиватели вращаемые из прозрачного окисленного терпированного стекла.

LED Sorgente luminosa LED a luce calda, 30.000 h di durata.



⊙ ⊕ IP44 LED

→ 6 ↑ 16 ↗ 13 cm
max 2 x 5W LED / 1100 Lm
129532 AP2

⊙ ⊕ IP44 LED

→ 6 ↑ 9 ↗ 13 cm
max 1 x 5W LED / 550 Lm
129525 AP1



Dot

Corpo luce in fusione di alluminio rifinito con vernice opaca a polveri. Diffusori in vetro temperato trasparente, uno superiore e uno inferiore.

Matt powder coated die-cast aluminium body. Top and bottom clear tempered glass diffusers. / Corps lumineux en fusion d'aluminium fini avec vernis mat à poudres. Diffuseurs en verre trempé transparent, l'un supérieur et l'autre inférieur. / Lichtkörper aus Aluminiumguss matt pulverlackiert. Lichtverteiler aus transparentem gehärtetem Glas, unten und oben. / Cuerpo de luz en fusión de aluminio acabado con barniz opaca a polvos. Difusor en vidrio temperado transparente, uno superior y otro inferior. / Корпус света из литого алюминия порошковой окраски. Рассеиватель из терпированного прозрачного стекла, верхнего и нижнего.



⊕ ⊖ P54

ø 117 x 6 cm
max 2 x 15W G9
143392 AP2 Antracite
140407 AP2 Bianco
140377 AP2 Nero



Tetris

Corpo luce in alluminio rifinito con vernice opaca a polveri. Diffusore in vetro temperato trasparente.

Aluminium body with matt powder coating. Clear tempered glass diffuser. / Corps lumineux en aluminium fini avec vernis mat à poudre. Diffuseur en verre trempé transparent. / Lichtkörper aus Aluminium matt pulverlackiert. Lichtverteiler aus transparentem gehärtetem Glas. / Cuerpo de luz en aluminio acabado con barniz opaca a polvos. Difusor en vidrio temperado transparente. / Корпус света из алюминия порошковой окраски. Рассеиватель из терпированного прозрачного стекла.



Tetris-1



- Antracite
- Bianco
- Grigio
- Nero



⊙ ⊕ IP44

→ 10 ↑ 9 ↗ 4 cm
max 1 x 15W G9

113753 Tetris-1 AP1 Antracite
114293 Tetris-1 AP1 Bianco
113760 Tetris-1 AP1 Grigio
113746 Tetris-1 AP1 Nero

⊙ ⊕ IP44

→ 4 ↑ 13 ↗ 9 cm
max 2 x 15W G9

113791 Tetris-2 AP2 Antracite
113777 Tetris-2 AP2 Bianco
113807 Tetris-2 AP2 Grigio
113784 Tetris-2 AP2 Nero

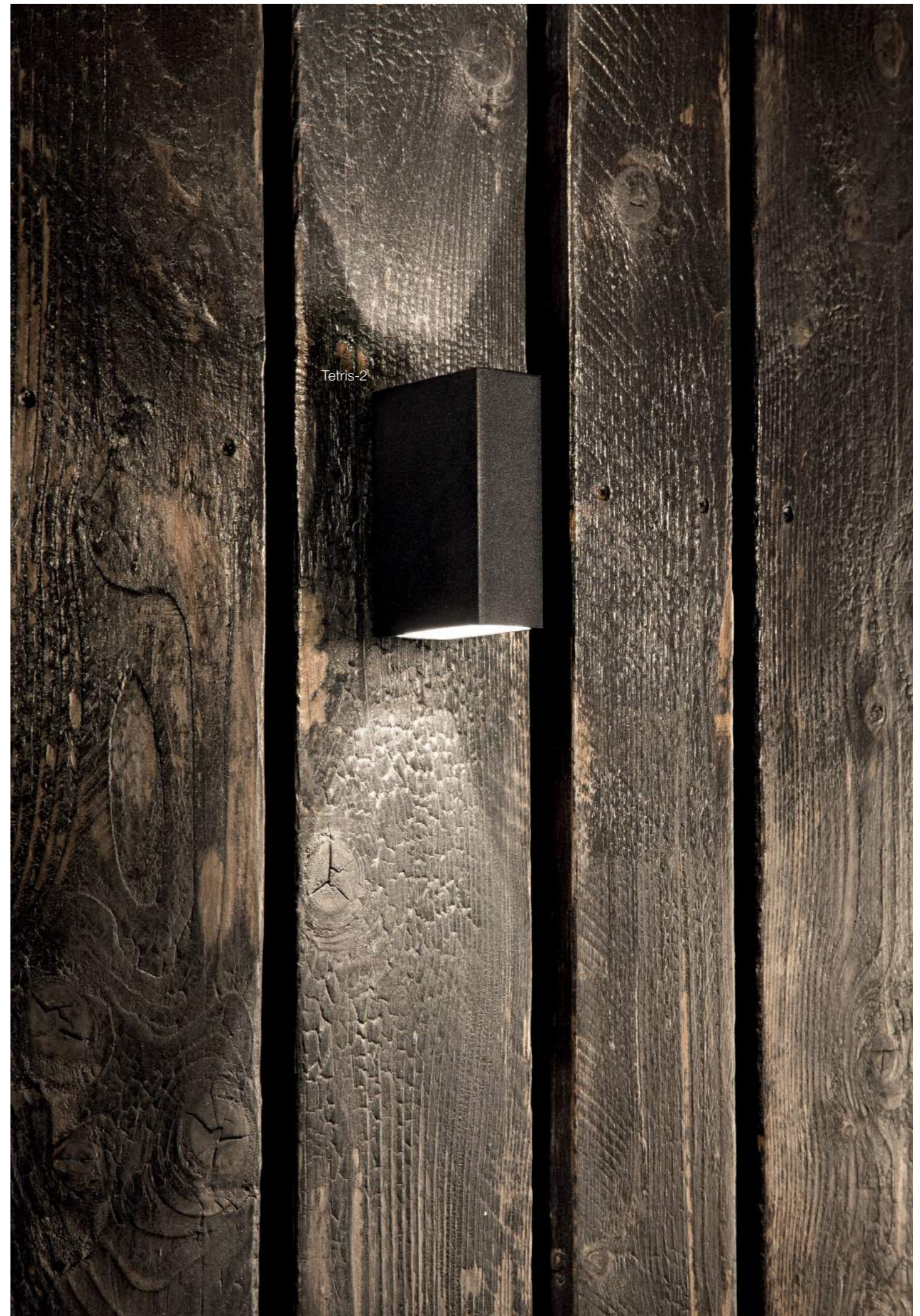

Tetris-2

Up

Corpo luce in fusione di alluminio verniciato a polveri. Diffusori in vetro pirex trasparente satinato.

Powder coated die-cast aluminum body. Frosted Pyrex glass diffusers. / Corps lumineux en fusion d'aluminium verni à poudre. Diffuseurs en verre pirex transparent satiné. / Lichtkörper aus Aluminiumguß pulverlackiert. Lichtverteiler aus Pyrexglas transparent satin. / Cuerpo de luz en fusión de aluminio barnizado a polvos. Difusor en vidrio pirex transparente arenado. / Корпус света из литого алюминия порошковой окраски. Рассеиватель из прозрачного стекла ругех матового цвета.

 Lampadine G9 28W incluse.



→ 6,5 ↑ 15 ↗ 9,5 cm
max 2 x 28W G9

115337 AP2 Antracite
115320 AP2 Bianco
115344 AP2 Nero



→ 6,5 ↑ 8 ↗ 9,5 cm
max 1 x 28W G9

115306 AP1 Antracite
115290 AP1 Bianco
115313 AP1 Nero



Iko

Corpo luce in alluminio pressofuso verniciato a polveri. Doppio diffusore, superiore e inferiore, in vetro temperato trasparente e sabbiato.

Powder coated die-cast aluminum body. Tempered and frosted clear glass up-and-down double diffuser. / Corps lumineux en aluminium moulé sous pression et verni à poudre. Double diffuseur, supérieur et inférieur, en verre transparent trempé et sablé. / Lichtkörper aus Aluminiumspritzguß pulverlackbeschichtet. Doppelter Lichtverteiler, oben und unten, aus gehärtetem Glas transparent und sandgestrahlt. / Cuerpo de luz en aluminio fundido barnizado a polvos. Difusor doble, superior e inferior, en vidrio temperado transparente arenado. / Корпус света из литого алюминия порошковой окраски. Двойной рассеиватель; верхний и нижний из терпированного стекла пескоструйной обработки.



IP55

→ 14 ↑ 7 ↓ 19 cm
max 1 x 60W E27

018515 AP1 Antracite
018522 AP1 Bianco
092218 AP1 Grigio
018539 AP1 Nero



Twin

Corpo luce in alluminio pressofuso verniciato a polveri. Doppio diffusore, superiore e inferiore, in vetro pirex trasparente satinato.

Powder coated die-cast aluminum body. Double, top and bottom, frosted Pyrex glass diffuser. / Corps lumineux en aluminium coulé sous pression et verni à poudres. Double diffuseur, supérieur et inférieur, en verre pyrex transparent satiné. / Lichtkörper aus Aluminiumspritzguß pulverlackiert. Doppelter Lichtverteiler, oben und unten, aus Pyrexglas transparent satin. / Cuerpo de luz en aluminio prefundido barnizado a polvos. Doble difusor, superior e inferior, en vidrio pirex transparente satinado. / Корпус света из литого алюминия порошковой окраски. Двойной рассеиватель: верхний и нижний из прозрачного стекла ругех матовой окраски.



Lampadine G9 28W incluse.



Antracite

Bianco



→ 16,5 ↑ 6,5 ↗ 11,5 cm
max 1 x 28W G9

115368 AP1 Antracite
115351 AP1 Bianco
115375 AP1 Nero



Nero

Down

Montatura in alluminio pressofuso verniciato a polveri. Diffusore in acrilico.

Die-cast aluminum body light with powder coat finish. Acrylic diffuser, with sandblasted inner side. / Monture en aluminium coulé sous pression et vernie à poudre. Diffuseur acrylique. / Gestell aus Aluminiumspritzguss pulverlackiert. Lichtverteiler Acryl. / Armazón en aluminio presofundido barnizado a polvos. Difusor en acrílico. / Арматура из литого алюминия порошковой окраски. Рассеиватель из акрила.

 Lampadine G9 28W incluse.



Antracite



Bianco



→ 8,5 ↑ 8,5 → 5 cm
max 1 x 28W G9
122045 AP1 Antracite
115382 AP1 Bianco

Bee

Corpo luce in alluminio pressofuso rifinito con vernice a polveri opaca. Diffusore in vetro temperato trasparente.

Die-cast aluminium reflecting body with matt powder coating. Clear tempered glass diffuser. / Corps lumineux en aluminium coulé sous pression et fini avec vernis mat à poudre. Diffuseur en verre trempé transparent. / Lichtkörper aus Aluminiumspritzguss matt pulverlackiert. Lichtverteiler aus gehärtetem transparentem Glas. / Cuerpo de luz en aluminio fundido acabado con barniz a polvos opaca. Difusor en vidrio temperado transparente. / Корпус света из литого алюминия порошковой окраски. Рассеиватель из темперированного стекла.



Bianco



Antracite



Nero



⊕ ⊖ P44

→ 12 ↑ 8,5 × 8 cm
max 2 x 15W G9

143385 AP2 Antracite
140131 AP2 Bianco
140124 AP2 Nero



Rubik

Corpo luce in fusione di alluminio verniciato a polveri. Struttura interna che riflette il fascio luminoso sia sopra sia sotto.

Cast aluminium body with powder coating. Up-and-down reflecting structure inside. / Corps lumineux en fusion d'aluminium verni à poudres. Structure interne qui reflète le faisceau lumineux soit en haut qu'en bas. / Lichtkörper aus Aluminiumguss pulverlackiert. Die innere Struktur reflektiert den Lichtstrahl oben und unten. / Cuerpo de luz en fusión de aluminio barnizado a polvos. Estructura interna que refleja el haz luminoso hacia arriba y hacia abajo. / Корпус света из литого алюминия порошковой окраски. Внутренняя структура отражает луч света как вверх так и вниз.

LED Sorgente luminosa LED a luce calda, 25.000 h di durata.



Antracite

Bianco



⊕ ⊖ P44 LED

→ 10 ↑ 10 ↘ 10 cm
max 1 x 6W LED / 570 Lm

149738 AP1 Antracite
149745 AP1 Bianco
142302 AP1 Nero



Nero

Keope













Corpo luce e diffusore in resina ad alte prestazioni; inattaccabile dalla corrosione di agenti atmosferici; colori stabilizzati da trattamento UV. Resistente a sbalzi termici da -60° C a + 90° C. Diffusori in materiale acrilico trasparente satinato.

High performance resin body and diffuser; resistant to corrosion caused by atmospheric agents; colours stabilized during UV treatment; thermal shock resistance from -60°C to + 90°C. Transparent satin acrylic diffusers. / Corps lumineux et diffuseur en résine à haute performance; inattaquable par la corrosion des agents atmosphériques. Couleurs stabilisés avec traitement UV. résistant aux écarts de température de -60° jusqu'à +90°. Diffuseurs de matière acrylique transparente mate. / Lichtkörper und Lichtverteiler aus bestleistendem Harz; Korrosionsunangrifflich von atmosphärischen Einwirkungen; Farben durch UV-Behandlung stabilisiert. Thermosprungfest von -60° C bis +90° C. Lichtverteiler aus Acrylmaterial transparent satin. / Cuerpo de luz y difusor en resina con altas prestaciones; inatacable en la corrosión de agentes atmosféricos, colores estables con tratamiento UV. Resistente a cambios térmicos desde -60° C a + 90° C. Difusores en material acrílico transparente satinado. / Корпус света и рассеиватель из смеси высокоэффективных смол; коррозионноустойчивый как от атмосферных факторов, так и химических элементов, цвета защищены от ультрафиолетового света, устойчивый к перепадам температур от -60° до +90° C. Рассеиватель из прозрачной акриловой пластины матовой отделки.

 Lampadine GU10 4,5W LED e LED E27 7W Sfera 4000 K include.

 Sorgente luminosa LED a luce fredda, 25.000 h di durata.



		
   ⇒ 16 ↑ 18,5 ↗ 14,5 cm max 1 x 23W E27 154800 AP1 Big Bianco 154817 AP1 Big Grigio 154824 AP1 Big Nero	   ⇒ 9 ↑ 16,5 ↗ 7,5 cm max 2 x 4,5W GU10 147772 AP2 Small Bianco 147796 AP2 Small Grigio 147819 AP2 Small Nero	   ⇒ 9 ↑ 16,5 ↗ 7,5 cm max 1 x 4,5W GU10 147765 AP1 Small Bianco 147789 AP1 Small Grigio 147802 AP1 Small Nero





Bianco



Apollo

Corpo luce in alluminio pressofuso rifinito con vernice opaca a polveri in colore bianco o nero. Diffusori in vetro temperato trasparente, uno superiore e uno inferiore.

Die-cast aluminium reflecting body with white or black matt powder coating. Top and bottom clear tempered glass diffusers. / Corps lumineux moulé sous pression, fini avec vernis mat à poudre en couleur blanc ou noir. Diffuseurs en verre trempé transparent, l'un supérieur et l'autre inférieur. / Lichtkörper aus Aluminiumspritzguss matt pulverlackiert, in den Farben weiß oder schwarz. Lichtverteiler aus transparentem, gehärtetem Glas, oben und unten. / Cuerpo de luz en aluminio fundido acabado con barniz opaca a polvos en color blanco o negro. Difusores en vidrio temperado. Transparente, uno superior y otro inferior. / Корпус света литого алюминия порошковой матовой окраски белого или черного цвета. Рассеиватель из прозрачного терпированного стекла, нижнее и верхнее.

LED Sorgente luminosa LED a luce calda, 25.000 h di durata.



⊕ ⊖ IP44 LED

→ 7 ↑ 11 ≥ 6 cm
max 2 x 3W LED / 400 Lm

137407 AP2 Round Bianco
137391 AP2 Round Nero

⊕ ⊖ IP44 LED

→ 6 ↑ 11 ≥ 6 cm
max 2 x 3W LED / 400 Lm

142470 AP2 Square Bianco
142463 AP2 Square Nero



Nero

Astro

Corpo luce in alluminio pressofuso verniciato a polveri. diffusore, in vetro pirex trasparente sabbiato.

Die-cast aluminum body with powder coat finish. Sandblasted transparent Pyrex glass diffuser. / Corps lumineux en aluminium moulé sous pression et verni à poudre. Diffuseur en verre pirex transparent sablé. / Lichtkörper aus Aluminiumspritzguß pulverlackbeschichtet. Lichtverteiler aus Pyrexglas transparent und sandgestrahlt. / Cuerpo de luz en aluminio fundido barnizado a polvos. Difusor en vidrio pirex transparente arenado. / Корпус света из литого алюминия порошковой окраски. Рассеиватель из прозрачного стекла ругех пескоструйной обработки.

 Lampadine G9 28W incluse.



Antracite



Bianco



Nero



  P44 

→ 6,5 ↑ 8 ↘ 9 cm
max 1 x 25W G9

092157 AP1 Antracite
092164 AP1 Bianco
092171 AP1 Nero



Gun

Corpo luce in alluminio con finitura naturale spazzolata o in vernice opaca nera o bianca. Diffusore in vetro pirex trasparente disponibile a luce singola o doppia, superiore e inferiore.

Aluminum body with natural brushed finish or with matt white or black varnish. Clear Pyrex glass diffuser available with single or up-and-down double light. / Corp lumineux en aluminium fini brossé naturellement ou en vernis mat noir ou blanc. Diffuseur en verre pirex transparent disponible à feu simple ou double, inférieur et supérieur. / Lichtkörper aus Aluminium natürlich mit Bürstung verarbeitet, matt schwarz oder weiß lackiert. Lichtverteiler aus transparentem Pyrexglas, mit Einzel oder Doppellicht, oben und unten, erhältlich. / Cuerpo de luz en aluminio con acabado natural cepillado o en barniz opaca negra o blanca. Difusor en vidrio pirex transparente disponible con luz individual o doble, superior e inferior. / Корпус света из алюминия с натуральной отделкой или окрашенного в белый или черный матовый цвет. Рассеиватель из прозрачного стекла ругех, доступен с одинарным или двойным светом, верхним и нижним.

 Lampadine GU10 28W incluse nei modelli: AP2 Small e PL1.



ø 10,5 ↑ 11 cm
max 1 x 28W GU10

092324 PL1 Alluminio
122663 PL1 Bianco
122687 PL1 Nero



→ 11 ↑ 31 ↗ 15 cm
max 2 x 60W E27

033020 AP2 Big Alluminio
092300 AP2 Big Bianco
092317 AP2 Big Nero



→ 6,5 ↑ 21 ↗ 11 cm
max 2 x 35W GU10

033013 AP2 Small Alluminio
100388 AP2 Small Bianco
100395 AP2 Small Nero



Base

Corpo luce in alluminio pressofuso rifinito con vernice a polveri opaca. Doppio diffusore, superiore e inferiore, in vetro temperato trasparente.

Die-cast aluminium reflecting body with matt powder coating. Double, top and bottom, clear tempered glass diffuser. / Corps lumineux en aluminium coulé sous pression et fini avec vernis mat à poudre. Double diffuseur, supérieur et inférieur, en verre trempé transparent. / Lichtkörper aus Aluminiumspritzguss matt pulverlackiert. Doppel-Lichtverteiler, oben und unten, aus gehärtetem transparentem Glas. / Cuerpo de luz en aluminio fundido acabado con barniz a polvos opaca. Doble difusor, superior e inferior, en vidrio temperado transparente. / Корпус света из литого алюминия порошковой окраски. Двойной рассеиватель, верхний и нижний из прозрачного терпированного стекла.



⊕ ⊖ P44

⇒ 6,5 ↑ 18 ↗ 11,5 cm
max 2 x 28W GU10

129457 AP2 Bianco
129440 AP2 Grigio
129433 AP2 Nero

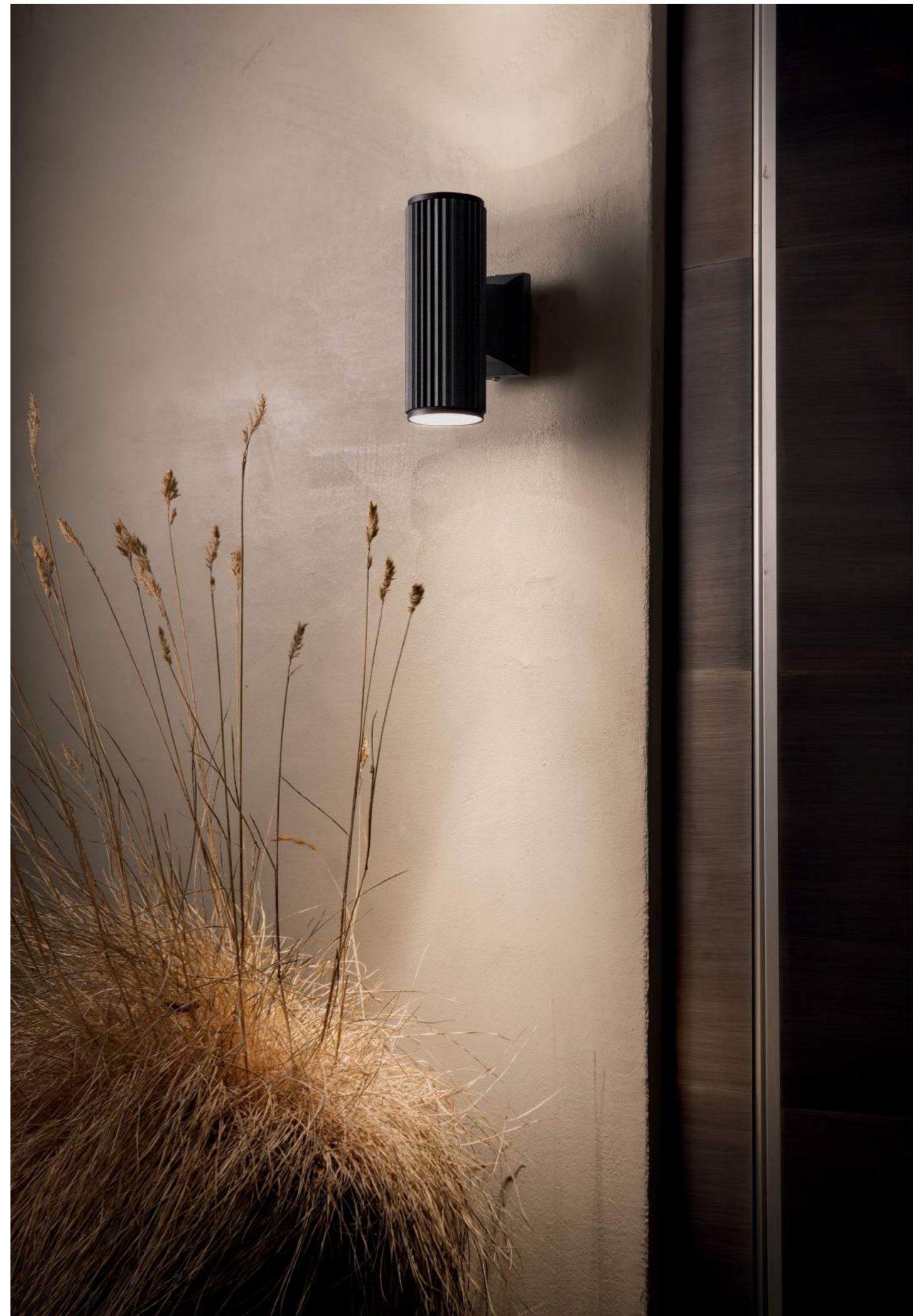

Snif Round

Corpo luce in alluminio pressofuso verniciato. Doppio diffusore, superiore e inferiore, in vetro pirex trasparente.

Die-cast aluminium body, with varnish finish. Transparent pyrex glass up-and-down double diffuser. / Corps en aluminium coulé sous pression et verni. Double diffuseur: supérieur et inférieur en verre pyrex transparent. / Lichtkörper aus Aluminiumspritzguss lackiert. Doppelter Lichtverteiler, oben und unten, aus transparentem Pirexglas. / Elemento de iluminación en aluminio fundido a presión acabado pintado. Difusor doble, superior e inferior, de vidrio pirex transparente. / Корпус из литого алюминия, покрытого краской. Двойной рассеиватель, верхний и нижний из стекла пирекс.

 Lampadine G9 28W incluse.



 P54

→ 11 ↑ 11 ↗ 15,5 cm
max 1 x 40W G9

061467 AP1 Round Antracite
144283 AP1 Round Bianco
061474 AP1 Round Grigio
061450 AP1 Round Nero

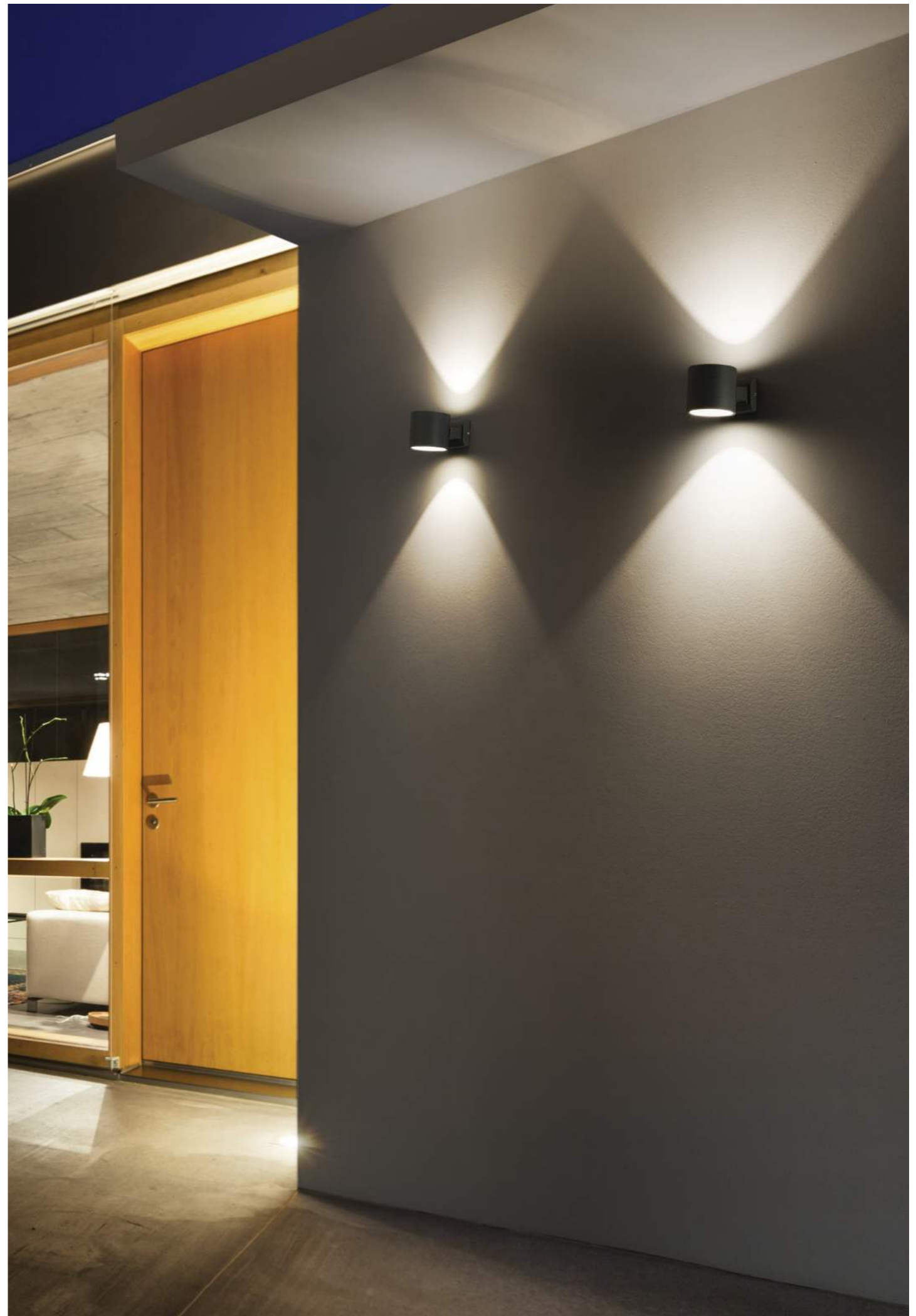

Snif Square

Corpo luce in alluminio pressofuso verniciato. Doppio diffusore, superiore e inferiore, in vetro pirex trasparente.

Die-cast aluminium body, with varnish finish. Transparent pyrex glass up-and-down double diffuser. / Corps en aluminium coulé sous pression et verni. Double diffuseur: supérieur et inférieur en verre pyrex transparent. / Lichtkörper aus Aluminiumspritzguss lackiert. Doppelter Lichtverteiler, oben und unten, aus transparentem Pirexglas. / Elemento de iluminación en aluminio fundido a presión acabado pintado. Difusor doble, superior e inferior, de vidrio pirex transparente. / Корпус из литого алюминия, покрытого краской. Двойной рассеиватель, верхний и нижний из стекла пирекс.

 Lampadine G9 28W incluse.



Antracite



Bianco



Nero



Grigio



→ 9 ↑ 10 ⇨ 14 cm
max 1 x 40W G9

121963 AP1 Square Antracite
144276 AP1 Square Bianco
118666 AP1 Square Grigio
123080 AP1 Square Nero



Andromeda

Corpo luce in alluminio pressofuso verniciato. Doppio diffusore, superiore e inferiore, in vetro pirex satinato.

Die-cast aluminum body light, with varnish finish. Frosted glass up-and-down double diffuser. / Corps lumineux en aluminium coulé sous pression et, verni. Double diffuseur, supérieur et inférieur, en verre pyrex satiné. / Lichtkörper aus Spritzguß-Alublock lackiert. Doppelter Lichtverteiler, oben und unten, aus Pirexglas satiniert. / Elemento de iluminación en aluminio fundido barnizado. Difusor doble, superior e inferior, de vidrio pirex satinado. / Корпус из литого алюминия, покрытого краской. Двойной рассеиватель, нижний и верхний из матового стекла пирекс.



⊕ ⊖ IP54

→ 45 ↑ 8 ↗ 9,5 cm
max 2 x 60W E27

092355 AP2 Antracite
100364 AP2 Bianco
100371 AP2 Nero

⊕ ⊖ IP55

→ 22 ↑ 8,5 ↗ 12 cm
max 1 x 60W E27

061580 AP1 Antracite
066868 AP1 Bianco
061597 AP1 Nero

■ Antracite

■ Bianco

■ Nero

Francy

Corpo luce e diffusore in resina ad alte prestazioni: inattaccabile dalla corrosione sia di agenti atmosferici che di fertilizzanti chimici, colori stabilizzati da trattamento U.V., resistente a sbalzi termici da -60° C a + 90° C.

High performance resin body: resistant to corrosion caused by both atmospheric agents and chemical fertilizers, colors stabilized during UV rays treatment, thermal shock resistance from -60° to +90°C. / Corps lumineux en résine de haute prestation: inattaquable par la corrosion, soit des agents atmosphériques que de fertilisants chimiques. Couleurs stabilisés avec traitement U.V., résistant à écarts de température de 60°C à + 90°C. / Lichtkörper und Lichtverteiler aus bestleistendem Harz: Korrosionsunangrifflich von atmosphärischen Einwirkungen und von chemischen Düngern, Farben durch UV-Behandlung stabilisiert, thermosprungfest von -60° C bis +90° C. / Cuerpo de luz y difusor en resina con altas prestaciones: inatacables por la corrosión sea por agentes atmosféricos que por fertilizantes químicos, colores estables por tratamiento U.V., resistente a cambios térmicos de -60° C a + 90° C. / Корпус света из смеси высокоэффективных смол: коррозионностойкий и с химической защитой от атмосферных явлений, цвета защищены от УФ лучей, стойкость температур от -60° C до + 90° C.



o □ IP66

→ 80 ↑ 13 ≥ 8,5 cm
max 1 x 23W E27

123745 Francy-1 AP1 Bianco
123738 Francy-1 AP1 Grigio
123752 Francy-1 AP1 Nero

o □ IP66

→ 30 ↑ 13 ≥ 8,5 cm
max 1 x 23W E27

123776 Francy-2 AP1 Bianco
123769 Francy-2 AP1 Grigio
123783 Francy-2 AP1 Nero



Giove

Corpo luce in alluminio pressofuso verniciato a polveri. Doppio diffusore, superiore e inferiore, in vetro temperato trasparente sabbiato.

Powder coated die-cast aluminum body. Double, top and bottom, frosted tempered clear glass diffuser. / Corps lumineux en aluminium moulé sous pression et verni à poudre. Double diffuseur, supérieur et inférieur, en verre transparent trempé et sablé. / Lichtkörper aus Aluminiumspritzguß pulverlackbeschichtet. Doppelter Lichtverteiler, oben und unten, aus gehärtetem Glas transparent und sandgestrahlt. / Cuerpo de luz en aluminio fundido barnizado a polvos. Difusor doble, superior e inferior, en vidrio temperado transparente arenado. / Корпус света из литого алюминия порошковой окраски. Двойной рассеиватель; как верхний так и нижний из закалённого прозрачного стекла пескоструйной обработки.



⊕ ⊖ IP54

→ 33 ↑ 8 ↓ 10 cm
max 1 x 60W E27

092188 AP1 Antracite
092195 AP1 Bianco
092201 AP1 Nero



Germana

Corpo luce e diffusore in resina ad alte prestazioni: inattaccabile dalla corrosione sia di agenti atmosferici che di fertilizzanti chimici, colori stabilizzati da trattamento U.V., resistente a sbalzi termici da -60° C a +90° C. Diffusore a inclinazione variabile.

High performance resin body: resistant to corrosion caused by both atmospheric agents and chemical fertilizers, colors stabilized during UV rays treatment, thermal shock resistance from -60° to +90°C. Multi-level adjustable diffuser. / Corps lumineux et diffuseur en résine de haute prestation: inattaquable par la corrosion, soit des agents atmosphériques que des fertilisants chimiques. Couleurs stabilisés avec traitement U.V., résistant aux écarts de température de 60°C à +90°C. Diffuseur à inclination variable. / Lichtkörper und Lichtverteiler aus bestleistungendem Harz: Korrosionsunangrifflich von atmosphärischen Einwirkungen und von chemischen Düngern. Farben durch UV-Behandlung stabilisiert. Thermosprungfest von -60° C bis +90° C. Lichtverteiler mit variabler Neigung. / Cuerpo de luz y difusor en resina con altas prestaciones: inatacable contra la corrosión sea por agentes atmosféricos que por fertilizantes químicos; colores estables por tratamiento U.V., resistentes a cambios térmicos de -60° C a +90° C. Difusor con inclinación variable. / Корпус света и рассеиватель из смеси смол: коррозионноустойчивый как от атмосферных факторов, так и химических элементов, цвета защищены от ультрафиолетового света, устойчивый к перепадам температур от -60°C до +90°C. Рассеиватель нагибаемый по вкусу.



Bianco



IP66

→ 18 ↑ 28 ↗ 90 cm
max 1 x 23W E27

120188 AP1 Bianco
120171 AP1 Nero



Nero

Bubble

Montatura in alluminio pressofuso e tornito rifinito con vernici a polveri. Diffusore in materiale plastico bianco opaco.

Turned die-cast aluminium body with powder coating. Matt white plastic diffuser. / Monture en aluminium coulé sous pression et travaillé sur tour, fini avec vernis à poudres. Diffuseur de matière plastique blanc mat. / Gestell aus Aluminiumspritzguss, gedreht und pulverlackbeschichtet. Lichtverteiler aus Plastik weiß matt. / Armazón en aluminio fundido y torneado acabado con barniz a polvos. Difusor en material plástico blanco opaco. / Арматура из литого выточенного алюминия порошковой окраски. Рассеиватель из матового белого пластикового материала.



⊕ ⊖ ⊕ P44
ø 33,5 ↑ 17 cm
max 1 x 60W E27
135250 PL1

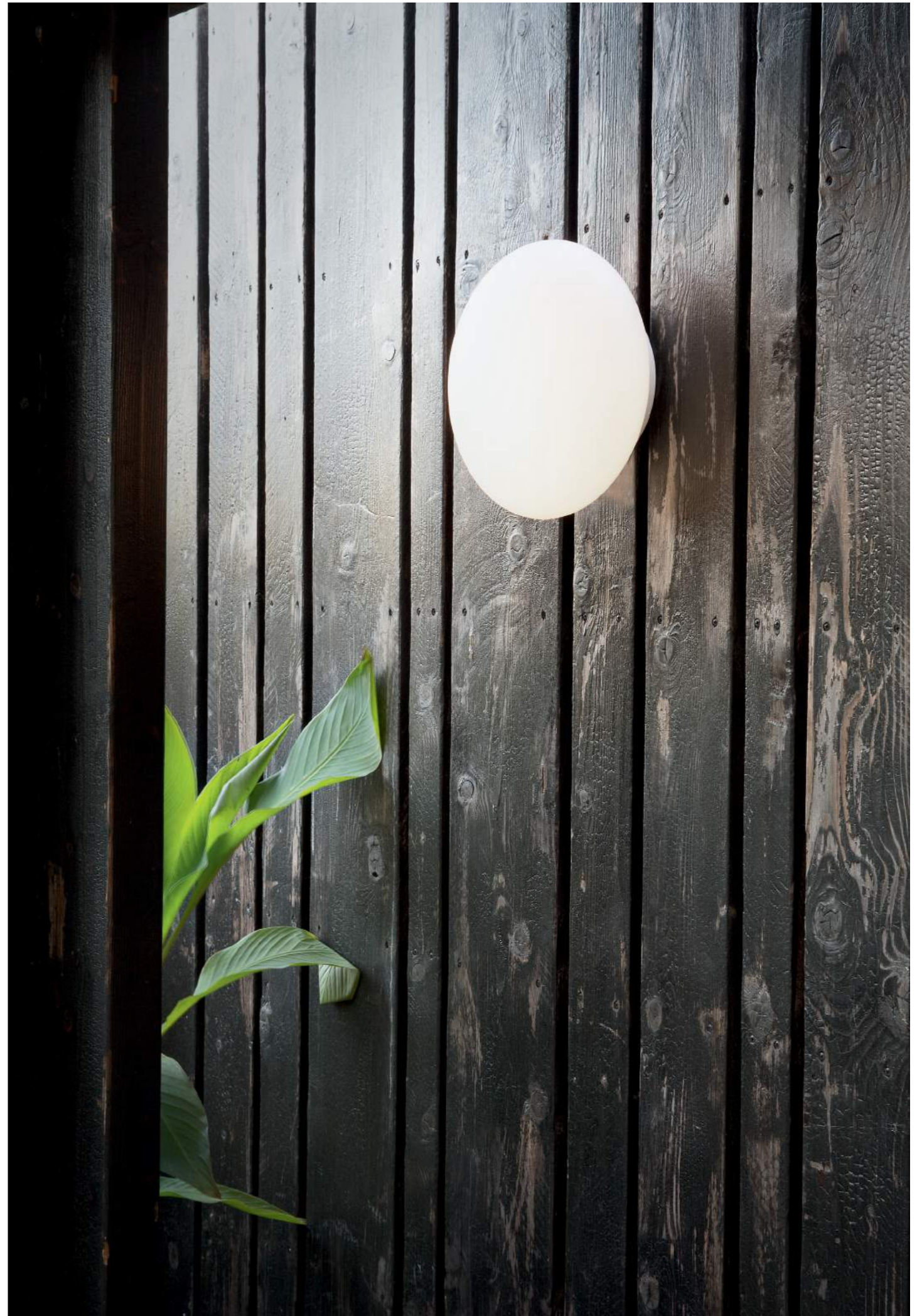

Berta

Corpo luce e diffusore in resina ad alte prestazioni: inattaccabile dalla corrosione sia di agenti atmosferici che di fertilizzanti chimici, colori stabilizzati da trattamento U.V., resistente a sbalzi termici da -60° C a + 90° C.

High performance resin body: resistant to corrosion caused by both atmospheric agents and chemical fertilizers, colours stabilized during UV rays treatment, thermal shock resistance from -60° to +90°C. / Corps lumineux et diffuseur en résine de haute prestation: inattaquable par la corrosion, soit des agents atmosphériques que des fertilisants chimiques, couleurs stabilisés avec traitement U.V., résistant à écarts de température de 60°C à + 90°C. / Lichtkörper und Lichtverteiler aus bestleistendem Harz: Korrosionsunangrifflich von atmosphärischen Einwirkungen und von chemischen Düngern, Farben durch UV-Behandlung stabilisiert, Thermosprungfest von -60° C bis + 90° C. / Cuerpo de luz y difusor en resina con altas prestaciones: inatacable en la corrosión sea por agentes atmosféricos que por fertilizantes químicos; colores estables por tratamiento U.V., resistente a cambios térmicos de -60°C a +90° C. / Корпус света и рассеиватель из смеси высокоэффективных смол: коррозионностойкий как от атмосферных факторов, так и химических элементов, цвета защищены от ультрафиолетового света, устойчивый к перепадам температур от -60° до + 90°.

 Lampadine GX53 11W/3W LED incluse.

 Sorgente luminosa LED a luce fredda, 25.000 h di durata.



Big	Medium	Small
Ø 36 ↑ 9,5 cm max 1 x 11W GX53	Ø 27,5 ↑ 8 cm max 1 x 11W GX53	Ø 20 ↑ 7 cm max 1 x 3W GX53
120713 AP1 Big Bianco 120720 AP1 Big Grigio 120706 AP1 Big Nero	096421 AP1 Medium Bianco 113340 AP1 Medium Grigio 096414 AP1 Medium Nero	096445 AP1 Small Bianco 122786 AP1 Small Grigio 096438 AP1 Small Nero



Lucia

Corpo luce e diffusore in resina ad alte prestazioni: inattaccabile dalla corrosione sia di agenti atmosferici che di fertilizzanti chimici, colori stabilizzati da trattamento U.V., resistente a sbalzi termici da -60° C a + 90° C.

High performance resin body and diffuser: resistant to corrosion caused by both atmospheric agents and chemical fertilizers, colours stabilized during UV rays treatment, thermal shock resistance from -60° to +90°C. / Corps lumineux et diffuseur en résine de haute prestation: inattaquable par la corrosion, soit des agents atmosphériques que des fertilisants chimiques, couleurs stabilisés avec traitement U.V., résistant à écarts de température de 60°C à + 90°C. / Lichtkörper und Lichtverteiler aus bestleistendem Harz: Korrosionsunangrifflich von atmosphärischen Einwirkungen und von chemischen Düngern, Farben durch UV-Behandlung stabilisiert, Thermosprungfest von -60° C bis + 90° C. / Cuerpo de luz y difusor en resina con altas prestaciones: inatacable en la corrosión sea por agentes atmosféricos que por fertilizantes químicos; colores estables por tratamiento U.V., resistente a cambios térmicos de -60°C a +90° C. / Корпус света и рассеиватель из смеси высокоэффективных смол: коррозионноустойчивый как от атмосферных факторов, так и химических элементов, цвета защищены от ультрафиолетового света, устойчивый к перепадам температур от -60° до + 90°.



Bianco



Nero



IP66

ø 30 ↑ 9 cm
max 1 x 23W E27

096667 Lucia-1 AP1 Bianco
096674 Lucia-1 AP1 Nero

IP66

ø 30 ↑ 9 cm
max 1 x 23W E27

096681 Lucia-2 AP1 Bianco
096698 Lucia-2 AP1 Nero



WALL AND CEILING



Nero



Bianco

Maddi

Corpo luce e diffusore in resina ad alte prestazioni: inattaccabile dalla corrosione sia di agenti atmosferici che di fertilizzanti chimici, colori stabilizzati da trattamento U.V., resistente a sbalzi termici da -60° C a + 90° C.

High performance resin body and diffuser: resistant to corrosion caused by both atmospheric agents and chemical fertilizers, colours stabilized during UV rays treatment, thermal shock resistance from -60° to +90°C. / Corps lumineux et diffuseur en résine de haute prestation: inattaquable par la corrosion, soit des agents atmosphériques que des fertilisants chimiques, couleurs stabilisés avec traitement U.V., résistant aux écarts de température de 60°C à + 90°C. / Lichtkörper und Lichtverteiler aus besteistendem Harz: Korrosionsunangrifflich von atmosphärischen Einwirkungen und von chemischen Düngern, Farben durch UV-Behandlung stabilisiert, Thermosprungfest von -60° C bis + 90° C. / Cuerpo de luz y difusor en resina con altas prestaciones: inatacable en la corrosión sea por agentes atmosféricos que por fertilizantes químicos; colores estables por tratamiento U.V., resistente a cambios térmicos de -60°C a +90° C. / Корпус света и рассеиватель из смеси высокоэффективных смол: коррозионностойкий как от атмосферных факторов, так и химических элементов, цвета защищены от ультрафиолетового света, устойчивый к перепадам температур от -60° до + 90°.



o □ IP66

→ 33 ↑ 23 ⇨ 9 cm
max 1 x 23W E27

096711 Maddi-1 AP1 Bianco
096704 Maddi-1 AP1 Nero

o □ IP66

→ 33 ↑ 23 ⇨ 9 cm
max 1 x 23W E27

096735 Maddi-2 AP1 Bianco
096728 Maddi-2 AP1 Nero

Rex

Corpo luce in alluminio pressofuso verniciato a polveri. Diffusore bianco in materiale acrilico.

Powder coated die-cast aluminum body. White acrylic diffuser. / Corps lumineux en aluminium moulé sous pression et verni à poudre. Diffuseur blanc en matière acrylique. / Lichtkörper aus Aluminiumspritzguß pulverlackbeschichtet. Lichtverteiler weiß aus Akrylmateriale. / Cuerpo de luz en aluminio fundido barnizado a polvos. Difusor blanco en material acrílico. / Корпус света из алюминия порошковой окраски. Рассеиватель белый из акрилового материала.



Rex-1



Rex-2



Rex-3



⊕ ⊖ IP44

→ 25 ↑ 12 ↗ 13 cm
max 1 x 60W E27

092409 Rex-1 AP1 Antracite
092393 Rex-1 AP1 Bianco

⊕ ⊖ IP44

→ 25 ↑ 12 ↗ 13 cm
max 1 x 60W E27

092423 Rex-2 AP1 Antracite
092416 Rex-2 AP1 Bianco

⊕ ⊖ IP44

→ 25 ↑ 12 ↗ 13 cm
max 1 x 60W E27

092447 Rex-3 AP1 Antracite
092430 Rex-3 AP1 Bianco

■ Antracite

■ Bianco

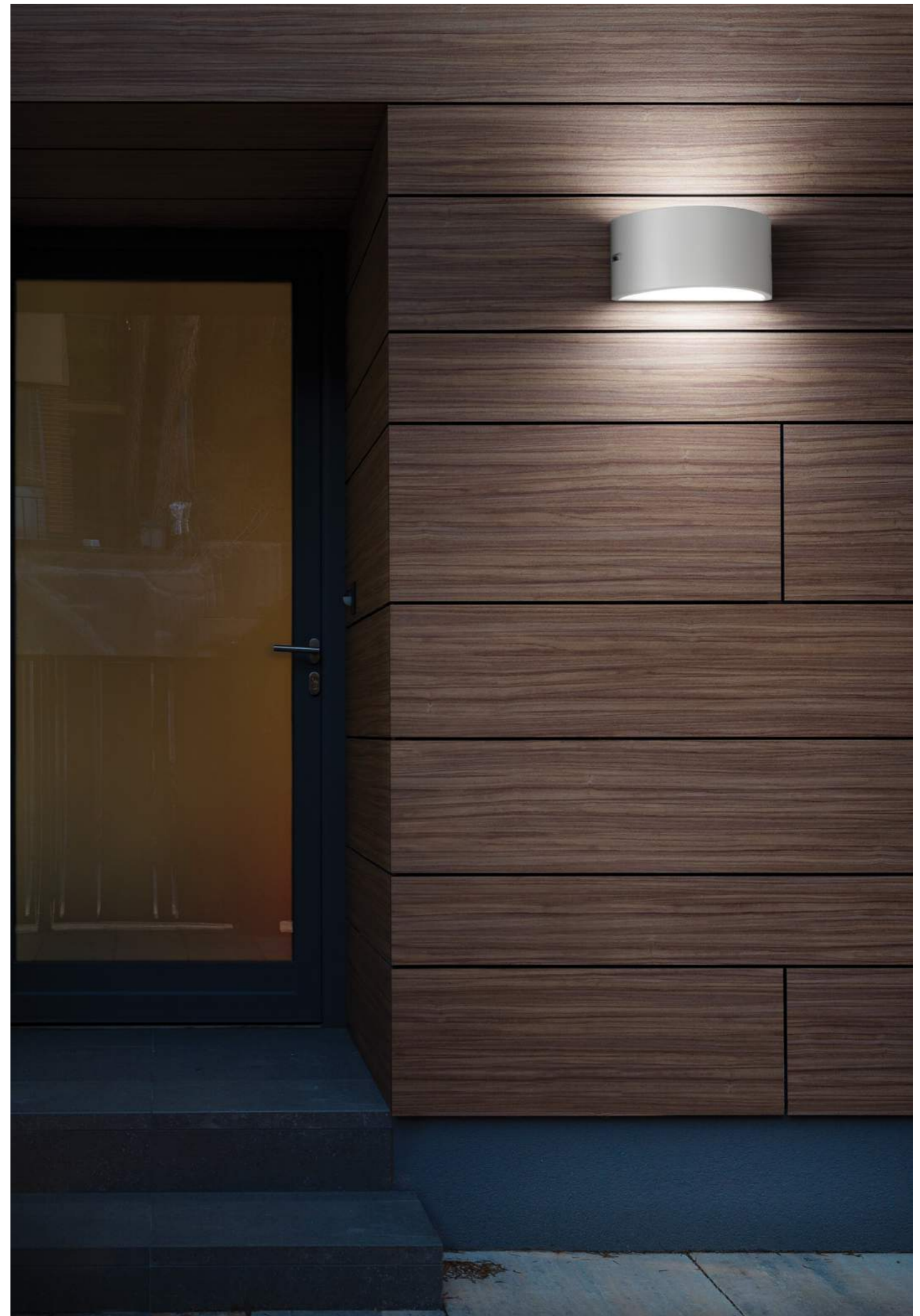

Mike

Corpo luce in blocco unico d'alluminio pressofuso rifinito in vernice. Diffusore in vetro pyrex.

One block die-cast aluminium body with varnish finish. Pyrex glass diffuser. / Corps en aluminium coulé sous pression, verni. Diffuseur en verre pyrex. / Lichtkörper in einem einzigen Spritzguß-Block lackiert. Lichtverteiler aus Pyrexglas. / Elemento de iluminación en un bloque único de aluminio fundido a presión acabado pintado. Difusor de vidrio pyrex. / Цельноалюминевый сварной корпус покрытый краской. Рассеиватель из стекла pyrex.

Antracite



Bianco



Nero



IP54

→ 82 ↑ 20,5 ↗ 12 cm
max 1 x 60W E27

061818 AP1 Blg Antracite
066882 AP1 Blg Bianco
061801 AP1 Blg Nero

IP65

→ 21,5 ↑ 19,5 ↗ 10 cm
max 1 x 25W E27

061788 AP1 Small Antracite
066899 AP1 Small Bianco
061771 AP1 Small Nero

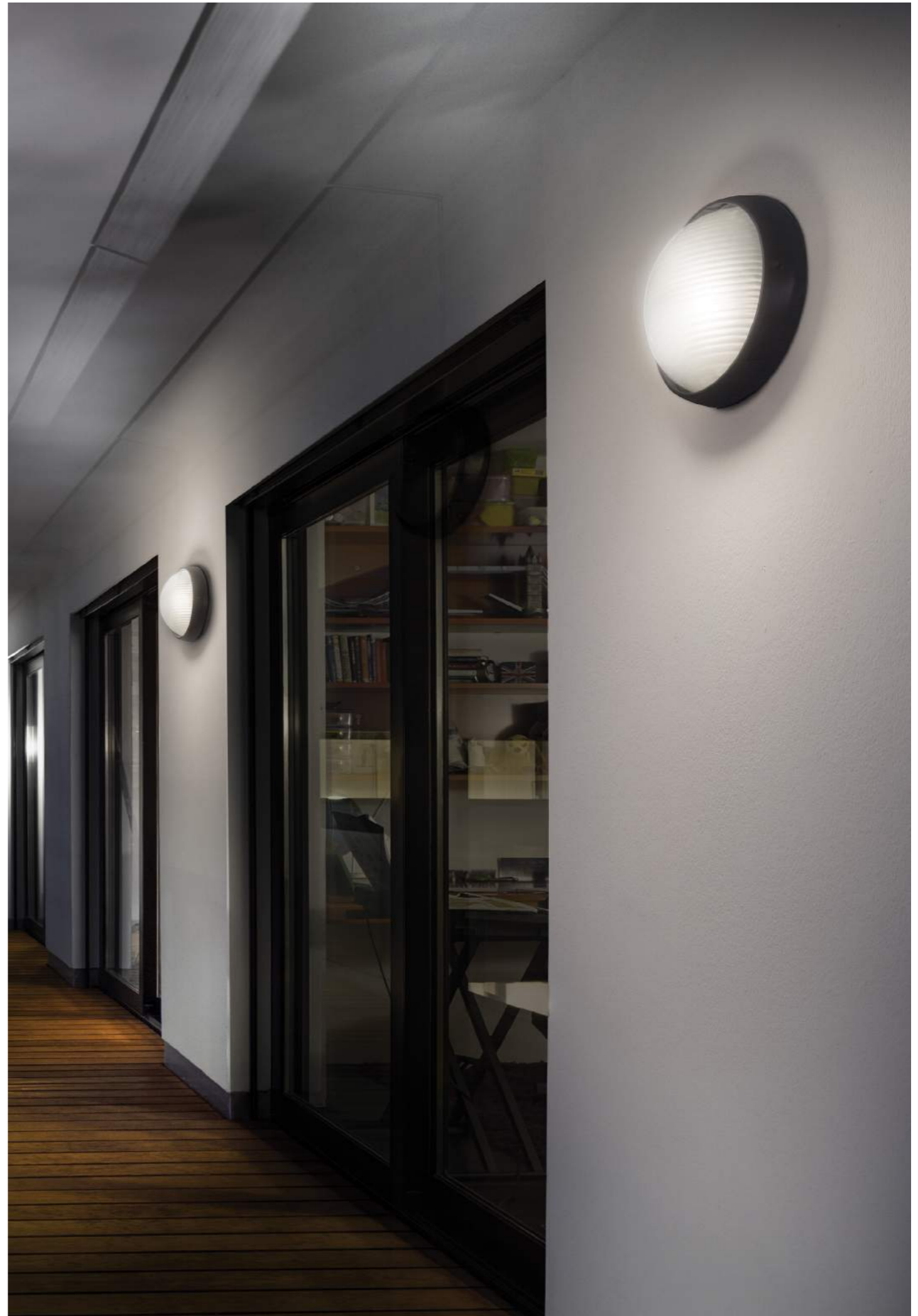



Nero

Cometa

Corpo luce in alluminio pressofuso rifinito con vernice a polveri. Diffusore in PVC bianco.

Die-cast aluminium body, powder coated finish. White PVC diffuser. / Corps lumineux en aluminium moulé sous pression et fini avec vernis à poudre. Diffuseur en PVC blanc. / Lichtkörper aus Aluminiumspritzguß mit Pulverlackierung. Lichtverteiler aus PVC weiß. / Cuerpo de luz en aluminio fundido acabado con barniz a polvos. Difusor en PVC blanco. / Корпус света из литого алюминия покрыт порошковой окраской. Рассеиватель из белого материала ПВХ.



⊕ ⊖ ⊕ IP54

⇒ 30 ↑ 30 ≥ 8,5 cm
max 3x28W E14

082240 FL3 Antracite
082271 FL3 Nero



Antracite



RECESSED

Leti

Corpo luce e diffusore in resina ad alte prestazioni: inattaccabile dalla corrosione sia di agenti atmosferici che di fertilizzanti chimici, colori stabilizzati da trattamento U.V., resistente a sbalzi termici da -60° C a +90° C.

High performance resin body and diffuser: resistant to corrosion caused by both atmospheric agents and chemical fertilizers, colours stabilized during UV rays treatment, thermal shock resistance from -60° to +90°C. / Corps lumineux et diffuseur en résine à haute performance: protégé contre la corrosion soit par intempéries que par engrais chimiques. Couleurs stabilisés par un traitement U.V. qui résistent aux chocs thermiques de -60° jusqu'à + 90°C. / Lichtkörper und Lichtverteiler aus bestleistungendem Harz: Korrosionsunangrifflich von atmosphärischen Einwirkungen und von chemischen Düngern, Farben durch UV-Behandlung stabilisiert, Thermosprungfest von -60° C bis + 90° C. / Cuerpo de luz y difusor en resina con altas prestaciones: inatacable en la corrosión sea por agentes atmosféricos que por fertilizantes químicos; colores estables por tratamiento U.V., resistente a cambios térmicos de -60°C a +90° C. / Корпус света и рассеиватель из смеси высокоэффективных смол: коррозионноустойчивый как от атмосферных факторов, так и химических элементов, цвета защищены от ультрафиолетового света, устойчивый к перепадам температур от -60° до + 90°.

 Lampadine GX53 3W LED incluse.

 Sorgente luminosa LED a luce fredda, 25.000 h di durata.







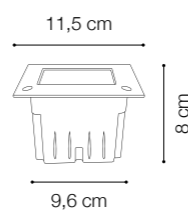
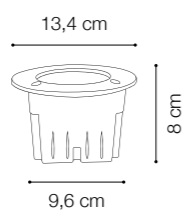

Nero



Bianco



  IP66  max 1 x 3W GX53
096544 R1 Round Bianco
096568 R1 Round Grigio
096551 R1 Round Nero

  IP66  max 1 x 3W GX53
096575 R1 Square Bianco
096599 R1 Square Grigio
096582 R1 Square Nero

Ceci

Corpo luce e diffusore in resina ad alte prestazioni: inattaccabile dalla corrosione sia di agenti atmosferici che di fertilizzanti chimici, colori stabilizzati da trattamento U.V., resistente a sbalzi termici da -60° C a +90° C. Carrabile fino a 5000 Kg.

High performance resin body: resistant to corrosion caused by both atmospheric agents and chemical fertilizers, colors stabilized during UV rays treatment, thermal shock resistance from -60° to +90°C. Resistant to 5000 kg impact. / Corps lumineux et diffuseur en résine de haute prestation: inattaquable par la corrosion, soit des agents atmosphériques que des fertilisants chimiques. Couleurs stabilisés avec traitement U.V., résistant aux écarts de température de 60°C à +90°C. / Lichtkörper und Lichtverteiler aus bestleistendem Harz: Korrosionsunangrifflich von atmosphärischen Einwirkungen und von chemischen Düngern. Farben durch UV-Behandlung stabilisiert. Thermosprungfest von -60° C bis +90° C. Befahrbar bis 5000 Kg. / Cuerpo de luz y difusor en resina con altas prestaciones: inatacable contra la corrosión sea por agentes atmosféricos que por fertilizantes químicos; colores estables por tratamiento U.V., resistentes a cambios térmicos de -60° C a +90° C. Transitable hasta un peso de 5000 kg. / Корпус света и рассеиватель из смеси смол: коррозионноустойчивый как от атмосферных факторов, так и химических элементов, цвета защищены от ультрафиолетового света, устойчивый к перепадам температур от -60°C до +90°C. Выдерживает до 5000 кг.

 Lampadine GU10 4,5W LED e GX53 10W LED incluse.

LED Sorgente luminosa LED a luce fredda, 25.000 h di durata.



RECESSED

Park

Spot da incasso al suolo o parete. Corpo luce esterno in PVC. Parabola riflettente in alluminio. Cornice blocca vetro in acciaio satinato. Vetro trasparente.

Recessed spotlight for wall or ground. PVC external body. Aluminum reflecting lens. Glazed steel glass-setting frame. / Spot à encastrer au sol ou au mur. Corps lumineux extérieur en PVC. Parabole réfléchissante en aluminium. Cadre circulaire verre en acier mat. Verre transparent. / Boden- oder Wandeinbauspot. Äußerer Lichtkörper aus PVC. Aluminium-Reflektor. Runder Glas-Blockierungsrahmen aus satiniertem Stahl. Transparentes Glas. / Spot empotrable al suelo o pared. Cuerpo de luz externo en PVC. Parábola reflectante en aluminio. Marco sujeta cristal en acero satinado. Vidrio transparente. / Встраиваемый спот в ровную с потолком или стеной. Внешний корпус света из материала ПВХ. Параболический отражатель из алюминия. Рамка фиксирующая стекло из стали. Стекло прозрачное.

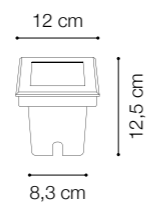
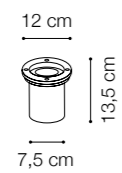
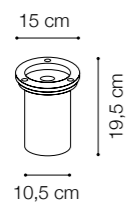

RECESSED

Cecilia

Corpo luce e diffusore in resina ad alte prestazioni: inattaccabile dalla corrosione sia di agenti atmosferici che di fertilizzanti chimici, colori stabilizzati da trattamento U.V., resistente a sbalzi termici da -60° C a +90° C. Carrabile fino a 5000 Kg.

High performance resin body: resistant to corrosion caused by both atmospheric agents and chemical fertilizers, colors stabilized during UV rays treatment, thermal shock resistance from -60° to +90°C. Resistant to 5000 kg impact. / Corps lumineux et diffuseur en résine de haute prestation: inattaquable par la corrosion, soit des agents atmosphériques que des fertilisants chimiques. Couleurs stabilisés avec traitement U.V., résistant aux écarts de température de 60°C à +90°C. / Lichtkörper und Lichtverteiler aus bestleistendem Harz: Korrosionsunangrifflich von atmosphärischen Einwirkungen und von chemischen Düngern. Farben durch UV-Behandlung stabilisiert. Thermosprungfest von -60° C bis +90° C. Befahrbar bis 5000 Kg. / Cuerpo de luz y difusor en resina con altas prestaciones: inatacable contra la corrosión sea por agentes atmosféricos que por fertilizantes químicos; colores estables por tratamiento U.V., resistentes a cambios térmicos de -60° C a +90° C. Transitable hasta un peso de 5000 kg. / Корпус света и рассеиватель из смеси смол: коррозионностойкий как от атмосферных факторов, так и химических элементов, цвета защищены от ультрафиолетового света, устойчивый к перепадам температур от -60°C до +90°C. Выдерживает до 5000 кг.



 Lampadine GU10 4,5W LED e GX53 10W LED incluse.

LED Sorgente luminosa LED a luce fredda, 25.000 h di durata.



Rocket

Apparecchio da incasso. Corpo luce in acciaio spazzolato. Diffusore in vetro pirex.

Recessed device. Brushed steel body, Pyrex glass diffuser. / Appareil à encastrer. Corps lumineux en aluminium brossé. Diffuseur en verre pyrex. / Einbaugerät. Lichtkörper aus Stahl gebürstet. Lichtverteiler aus Pyrexglas. / Aparato empotrado. Cuerpo de luz en acero cepillado. Difusor en vidrio pirex. / Встраиваемый светильник. Корпус света из матовой стали. Рассеиватель из стекла пирекс.

LED Sorgente luminosa LED a luce calda, 15.000 h di durata.

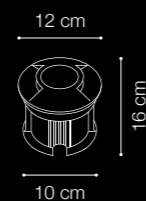
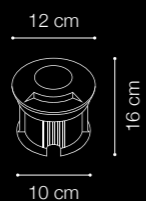

IP65 LED
max 1 x 3W LED / 200 Lm
122014 Rocket-1 PT1



IP65 LED
max 1 x 3W LED / 200 Lm
122021 Rocket-2 PT1



LIGHT BULBS AND ACCESSORIES

LED Classic

Lampadine di vetro con led a filamento. Riproducono esattamente l'estetica delle lampadine tradizionali. Disponibili trasparenti o bianche per una luce più diffusa. Bassi consumi, lunga durata e facilità di sostituzione.

LED filament glass bulbs. A true reproduction of traditional bulbs appearance. Available colours: transparent and white to obtain indirect light. Low energy consumption, long life and simple replacement. / Ampoules en verre avec led à filament. Elles reproduisent exactement l'aspect des ampoules traditionnelles. Disponibles transparentes ou blanches pour une lumière plus diffuse. Économies, de longue durée et facilement remplaçables. / Leuchtmittel aus Glas mit Filament-LED, genaue Nachbildung der traditionellen Glühlampen. Transparent oder weiß, für diffuseres Licht, verfügbar. Geringer Energieverbrauch, lange Lebensdauer und einfacher Austausch. / Bombillas de vidrio con led a filamento. Reproducen exactamente la estética de las bombillas tradicionales. Disponibles transparentes o blancas para una luz más difusa. Bajo consumo, larga duración y facilidad en la sustitución. / Лампочки из стекла с нитью накала led. Эстетически, они полностью воспроизводят традиционные лампочки. Доступны в прозрачные или белые для более распространённого света. Низкое потребление, долгосрочные и просты в замене.



CLASSIC E14 Sfera trasparente
 ø 4,5 ↑ 7,8 cm
 Attacco E14
 4 W - 430 Lm
 15000 ore
 Code: 101200 3000 K
 153926 4000 K

CLASSIC E14 Oliva trasparente
 ø 3,5 ↑ 9,8 cm
 Attacco E14
 4 W - 430 Lm
 15000 ore
 Code: 101224 3000 K
 153933 4000 K

CLASSIC E14 Colpo di vento trasparen.
 ø 3,5 ↑ 11,5 cm
 Attacco E14
 4 W - 430 Lm
 15000 ore
 Code: 101248 3000 K
 153940 4000 K

CLASSIC G4 1,5W Plastica
 ø 1,3 ↑ 3,7 cm
 Attacco G4 / 12V
 1,5 W - 120 Lm - 3000 K
 25000 ore
 Code: 123929

CLASSIC G4 1,8W Ceramica
 ø 1,3 ↑ 4,4 cm
 Attacco G4 / 12V
 1,8 W - 144 Lm - 3000 K
 25000 ore
 Code: 101361

CLASSIC E14 Sfera bianco
 ø 4,5 ↑ 7,8 cm
 Attacco E14
 4 W - 360 Lm - 3000 K
 15000 ore
 Code: 101217

CLASSIC E14 Oliva bianco
 ø 3,5 ↑ 9,8 cm
 Attacco E14
 4 W - 360 Lm - 3000 K
 15000 ore
 Code: 101231

CLASSIC E14 Colpo di vento bianco
 ø 3,5 ↑ 11,5 cm
 Attacco E14
 4 W - 360 Lm - 3000 K
 15000 ore
 Code: 151793

CLASSIC G9 2,5W Plastica
 ø 1,5 ↑ 4,6 cm
 Attacco G9
 2,5 W - 200 Lm - 3000 K
 25000 ore
 Code: 122168

CLASSIC G9 3W Silicene
 ø 1,55 ↑ 4,9 cm
 Attacco G9
 3 W - 240 Lm - 3000 K
 25000 ore
 Code: 051420

CLASSIC G9 3,5W Plastica
 ø 1,65 ↑ 5 cm
 Attacco G9
 3,5 W - 280 Lm
 25000 ore
 Code: 129167 3000 K
 153995 4000 K

CLASSIC E14 Sfera cromo
 ø 4,5 ↑ 7,5 cm
 Attacco E14
 4 W - 260 Lm - 3000 K
 15000 ore
 Code: 101262

CLASSIC E14 Spot
 ø 5 ↑ 8,7 cm
 Attacco E14
 4 W - 430 Lm - 3000 K
 15000 ore
 Code: 101255

CLASSIC E27 Goccia cromo
 ø 6 ↑ 10,5 cm
 Attacco E27
 4/8 W - 260/520 Lm - 3000 K
 15000 ore
 Code: 101316 4 W
 123882 8 W

CLASSIC GU10 5W Ceramica
 ø 5 ↑ 6 cm
 Attacco GU10
 5 W - 400 Lm - 3000 K
 25000 ore
 Code: 051413

CLASSIC GU10 7W Ceramica
 ø 5 ↑ 6 cm
 Attacco GU10
 7 W - 560 Lm
 25000 ore
 Code: 101378 3000 K
 117652 4000 K

CLASSIC GU10 Vetro
 ø 5 ↑ 5,5 cm
 Attacco GU10
 5/7 W - 400/560 Lm - 3000 K
 25000 ore
 Code: 108292 5 W
 123943 7 W

CLASSIC E27 Sfera trasparente
 ø 4,5 ↑ 7,5 cm
 Attacco E27
 4 W - 430 Lm
 15000 ore
 Code: 101279 3000 K
 153957 4000 K

CLASSIC E27 Goccia trasparente
 ø 6 ↑ 10,5 cm
 Attacco E27
 15000 ore
 Code: 101293 4W 430 Lm 3000 K
 119571 8W 860 Lm 3000 K
 153964 8W 860 Lm 4000 K

CLASSIC E27 Globo trasparente
 Attacco E27
 8 W - 860 Lm
 15000 ore
 Code: 101323 ø 95 3000 K
 153971 ø 95 4000 K
 101347 ø 125 3000 K
 153988 ø 125 4000 K

CLASSIC GX53 7W
 ø 7,5 ↑ 2,5 cm
 Attacco GX53
 7 W - 560 Lm - 3000 K
 25000 ore
 Code: 101385

CLASSIC GX53 9,5W
 ø 7,5 ↑ 2,9 cm
 Attacco GX53
 9,5 W - 760 Lm
 25000 ore
 Code: 123936 3000 K
 154008 4000 K

CLASSIC E27 Sfera bianco
 ø 4,5 ↑ 7,5 cm
 Attacco E27
 4 W - 360 Lm - 3000 K
 15000 ore
 Code: 101286

CLASSIC E27 Goccia bianco
 ø 6 ↑ 10,5 cm
 Attacco E27
 4/8 W - 360/720 Lm - 3000 K
 15000 ore
 Code: 101309 4 W
 123899 8 W

CLASSIC E27 Globo bianco
 Attacco E27
 8 W - 720 Lm - 3000 K
 15000 ore
 Code: 101330 ø 95
 101354 ø 125

CLASSIC R7s 4W 78 mm
 ø 1,8 → 7,8 cm
 Attacco R7s
 4 W - 320 Lm - 3000 K
 25000 ore
 Code: 123950

CLASSIC R7s 8W 118 mm
 ø 1,9 → 11,8 cm
 Attacco R7s
 8 W - 640 Lm - 3000 K
 25000 ore
 Code: 123967

LED Power

Lampadine di plastica con led integrati. I diffusori in plastica bianca garantiscono una buona diffusione della luce. Bassi consumi, lunga durata e facilità di sostituzione.

Plastic bulb with integrated LED sources. White plastic diffusers guarantee a good light diffusion. Low energy consumption, long life and simple replacement. / Ampoules en plastique avec led intégrés. Les diffuseurs en plastique blanche assurent une bonne propagation de la lumière. Économes, de longue durée et facilement remplaçables. / Leuchtmittel aus Plastik mit integrierten LED. Lichtverteiler aus weißem Plastik gewährleisten eine gute Lichtverteilung. Geringer Energieverbrauch, lange Lebensdauer und einfacher Austausch. / Bombillas de plástico con led integrados. Los difusores en plástico blanco garantizan una buena difusión de la luz. Bajo consumo, larga duración y facilidad en la sustitución. / Лампочки из пластмассы с встроенным диодом. Рассеиватели из белой пластмассы гарантируют хорошее рассеивание света. Низкое потребление, долгосрочные и просты в замене.



POWER E14 Sfera

ø 4,5 ↑ 8 cm
Attacco E14
7 W - 560 Lm
25000 ore

Code: 151731 3000 K
151946 4000 K



POWER E14 Oliva

ø 3,5 ↑ 9,5 cm
Attacco E14
7 W - 560 Lm
25000 ore

Code: 151748 3000 K
151953 4000 K



POWER E27 Sfera

ø 4,5 ↑ 8 cm
Attacco E27
7 W - 560 Lm
25000 ore

Code: 151755 3000 K
151960 4000 K



POWER E27 Goccia

ø 6 ↑ 10,5 cm
Attacco E27
10 W - 800 Lm
25000 ore

Code: 151762 3000 K
151991 4000 K



POWER E27 Globo small

ø 9,5 ↑ 14,5 cm
Attacco E27
12 W - 960 Lm
25000 ore

Code: 151779 3000 K
151977 4000 K



POWER E27 Globo big

ø 12 ↑ 15,5 cm
Attacco E27
15 W - 1200 Lm
25000 ore

Code: 151786 3000 K
152004 4000 K



POWER E27 2U

ø 4 ↑ 14 cm
Attacco E27
8,5 W - 680 Lm
25000 ore

Code: 151809 3000 K
151816 4000 K

Strip LED

LED modulari su nastro flessibile con dorso adesivo. Venduti a bobine di 5 metri. Il nastro può essere tagliato a piacere. In base alla lunghezza va abbinato un driver di adeguata potenza. Nella versione a IP20 i circuiti sono scoperti, mentre in quella a IP65 sono protetti da uno strato di silicone.

Modular LED sources on flexible adhesive tape. Purchasable on reels of 5 meters each. The strip can be cut according to one's preferences. A driver of adequate power rating must conform to the length. The model with IP20 has uncovered electric circuits; the model with IP65 has the circuits protected with silicon layer. / LED modulaires sur bande flexible avec support autocollant. Vendus en bobines de 5 metres. La bande peut être coupée à plaisir. Selon la longueur, il faut assortir un ballast de puissance suffisante. Dans la version IP20, les circuits sont découverts tandis que dans celle à IP65 ils sont protégés par une couche de silicone. / LED-Module auf flexiblem Klebeband. In 5 Meter-Rollen geliefert. Das Band kann wunschgemäß geschnitten werden. Je nach Bandlänge ist ein Driver der geeigneter Leistung zu verbinden. Bei IP20 ist die Schaltung ungedeckt, bei IP65 mit Silikon-Schutz bezogen. / LED modular sobre cinta flexible con dorso adhesivo. Vendidos en bobinas de 5 metros. La cinta se puede cortar al placer. Según el largo que se elige añadimos un driver adecuado a la potencia. En la versión IP20 los circuitos están cerrados, mientras en la versión de IP65 están protegidos por una capa de silicona. / ЛЕД модулированы на гибкой ленте с клейкой на обратной стороне. Продаётся по 5-и метровым катушкам. Лента может отрезана по вкусу. В зависимости от длины подбирается драйвер соответствующей мощности. В версии IP20 эл.схема открыта, в то время как в версии IP65 эта часть защищена силиконовым слоем.



→ 500 ↑ 1 ↗ 0,15 cm
max 26W x 1 m / 24V
IP20 - 2400 Lm/m - 25000 ore
151847 3000 K
151854 4000 K



→ 500 ↑ 1 ↗ 0,15 cm
max 13W x 1 m / 24V
1200 Lm/m - 25000 ore
124032 3000 K IP20
124056 3000 K IP65
124049 4000 K IP20
124063 4000 K IP65



→ 11,5 ↑ 3 ↗ 21,5 cm
IP20 / 24V
153001 Driver 200W



→ 10 ↑ 4 cm
IP20 / 24V
124100 Driver 100W ↗ 16,5 cm
124117 Driver 150W ↗ 20 cm



→ 5,5 ↑ 3,5 cm
IP20 / 24V
124070 Driver 30W ↗ 9,5 cm
124087 Driver 60W ↗ 15,5 cm

26 W

SMD 2835/CRI 80

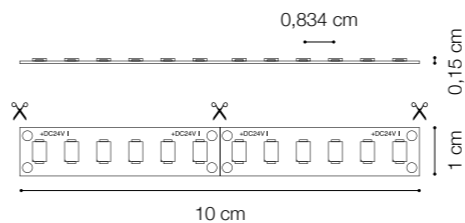

13 W

SMD 2835/CRI 80

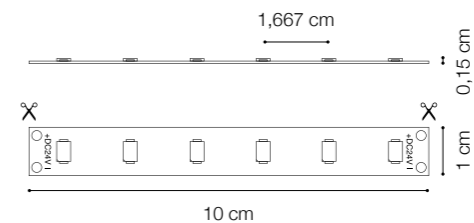

Profili LED

Profili in alluminio per LED modulari. Forniti in kit che include: un profilo da un metro, un diffusore in policarbonato trasparente satinato, due clip metalliche per il fissaggio, due coperchi per le estremità di cui una preforata per il passaggio dei cavi elettrici.

Modular aluminum LED profiles. Supplied in kit, including: one 1 meter long profile, one clear polycarbonate diffuser with satin finish, two metal clips for fixing, two covers for the ends (one of which is pierced to permit the passage of electrical cables). / Profils en aluminium pour LED modulaires. Présentés en kit qui inclut : modules d'un mètre, un diffuseur en polycarbonate transparent mat, deux clips métalliques pour la fixation, deux bâches pour les extrémités, dont l'une est perforée pour le passage des câbles électriques. / Aluminiumprofile für LED-Module. Im Kit geliefert, bestehend aus: 1 Meter Profil, ein Lichtverteiler aus Polycarbonat transparent satiniert, zwei Metall Befestigung-Clips, zwei Endabdeckungen, eine davon mit Bohrung für Kabeleinführung. / Perfiles en aluminio para LED modulares. Provistos en kit que incluye: un perfil de un metro, un difusor en policarbonato transparente satinado, dos pinzas metálicas para la fijación, dos tapaderas para las extremidades una de ellas preforada para el pase de los cables eléctricos. / Профиль из алюминия для модулированного ЛЕД. Поставляются в комплекте, который включает: однометровый профиль, рассеиватель из прозрачного матового поликарбоната, два металлических зажима для крепления, два конечных закрытия, из которых одно перфорировано для эл.проводов.

Kit profilo angolare

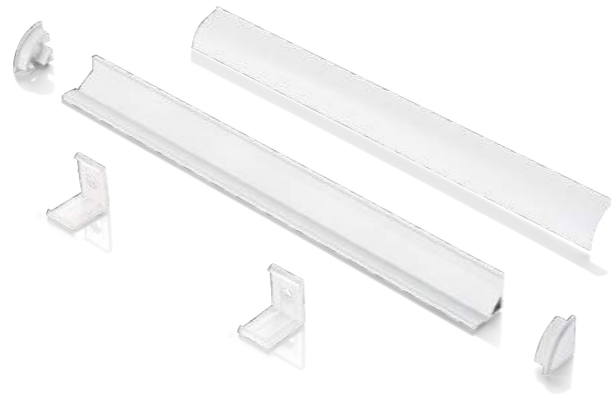

Kit profilo a vista



Kit profilo ad incasso

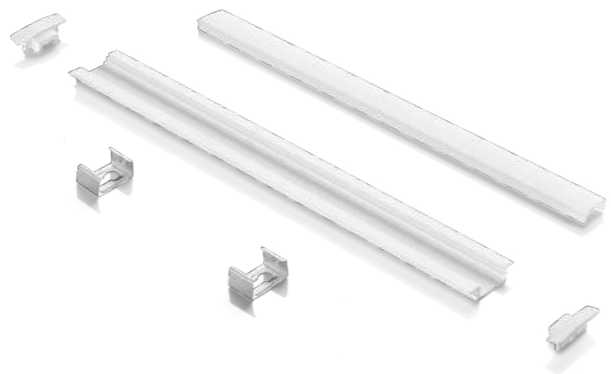

→ 100 ↑ 1,6 ↗ 1,6 cm
126531 Angolare Alluminio
126548 Angolare Bianco



→ 100 ↑ 0,5 ↗ 1,5 cm
124124 Vista Alluminio
124131 Vista Bianco



→ 100 ↑ 0,5 ↗ 2,5 cm
124148 Incasso Alluminio
124155 Incasso Bianco



Alogene

Luminosità intensa, risparmio di energia fino al 30%. Prodotte anche con le classiche forme delle lampadine tradizionali.

High brightness, energy saving up to 30%. Manufactured also in classic shapes of traditional bulbs. / Intense luminosité, économie d'énergie jusqu'à 30%. On les produit aussi dans la forme classique d'une ampoule traditionnelle. / Starke Helligkeit, Energiesparung bis zu 30%. Hergestellt auch in den klassischen Formen der traditionellen Glühlampen. / Luz intensa, ahorro de energia hasta el 30%. Producido también con las formas clásicas de las bombillas tradicionales. / Интенсивное освещение, энергосбережение до 30%. Произведены также в форме традиционной лампочки.



ALO E14 Sfera
 ø 4,5 ↑ 7,7 cm
 Attacco E14
 28 W - 405 Lm -2700 K
 2000 ore
 Code: 039534



ALO E14 Oliva
 ø 3,5 ↑ 9,6 cm
 Attacco E14
 28 W - 405 Lm -2700 K
 2000 ore
 Code: 039510



ALO E14 Colpo di vento
 ø 3,5 ↑ 11,6 cm
 Attacco E14
 28 W - 405 Lm -2700 K
 2000 ore
 Code: 063714



ALO E14 Sfera cromo
 ø 4,5 ↑ 7,9 cm
 Attacco E14
 28 W - 250 Lm -2700 K
 1500 ore
 Code: 061917



ALO E14 Spot
 ø 5 ↑ 8,5 cm
 Attacco E14
 28 W - 405 Lm -2700 K
 1500 ore
 Code: 059426



ALO E27 Goccia cromo
 ø 6 ↑ 9,6 cm
 Attacco E27
 42 W - 330 Lm -2700 K
 1500 ore
 Code: 039893



ALO E27 Sfera
 ø 4,5 ↑ 7 cm
 Attacco E27
 42 W - 530 Lm -2700 K
 2000 ore
 Code: 061023



ALO E27 Goccia
 ø 5,5 ↑ 9,8 cm
 Attacco E27
 42 W - 530 Lm -2700 K
 2000 ore
 Code: 057620



ALO E27 Globo
 Attacco E27
 2700 K
 1500 ore
 Code: 007779 ø 95 42 W 530 Lm
 061038 ø 125 20 W 320 Lm
 041766 ø 125 42 W 530 Lm



ALO G4
 ø 0,9 ↑ 3,1 cm
 Attacco G4 / 12V
 10/20 W - 140/320 Lm -2700 K
 2000 ore
 Code: 024677 10 W
 024684 20 W



ALO G9
 ø 1,4 ↑ 4 cm
 Attacco G9
 28 W - 405 Lm -2700 K
 1500 ore
 Code: 047881



ALO GU10 28W
 ø 5 ↑ 5,7 cm
 Attacco GU10
 28 W - 405 Lm -2700 K
 2000 ore
 Code: 058740



ALO GU10 50W
 ø 11,1 ↑ 7,5 cm
 Attacco GU10
 50 W - 725 Lm -2700 K
 1500 ore
 Code: 141299



ALO R7s 78mm
 ø 1 → 7,8 cm
 Attacco R7s
 70 W - 1230 Lm -2700 K
 1000 ore
 Code: 026343 70W



ALO R7s 118mm
 ø 1 → 11,8 cm
 Attacco R7s
 120 W - 2200 Lm -2700 K
 1000 ore
 Code: 026398



E14 Sfera

E27 Goccia

E27 Globo small

E14 Spot

E14 Oliva

E14 Colpo di vento

E27 Goccia cromo

Cup

Rosoni a luce singola o multipla in metallo con finiture varie. Cavi non inclusi.

Ceiling cups with single or multiple light plank with different finishes. Cables not provided. / Pavillons à feu simple ou multiple, en métal avec plusieurs finitions. Les câbles ne sont pas inclus. / Deckenrosetten mit Einzel- oder Mehrfach-Licht, aus Metall in verschiedenen Farben erhältlich. Kabel nicht inbegriffen. / Flornes con luz individual o múltiple en metal con varios acabado. Cables no incluidos. / Потолочные чаши с одинарным или множественным выходами в разных покрытиях. Тросы не входят в комплект.





Cup MSB3



Cup MSP5



Cup MSP1

-  Bianco
-  Cromo
-  Nero





			
ø 10 ↑ 9 cm	→ 10 ↑ 9 ↗ 10 cm	→ 88 ↑ 4,5 ↗ 7,5 cm	ø 10 ↑ 4 cm
138091 MSP5 Round Bianco 138107 MSP5 Round Cromo 138114 MSP5 Round Nero	138053 MSP5 Square Bianco 138077 MSP5 Square Cromo 138084 MSP5 Square Nero	122854 MSB3 Bianco 122861 MSB3 Cromo 123301 MSB3 Nero	122823 MSP1 Bianco 122830 MSP1 Cromo 123295 MSP1 Nero

Cavi e supporti

Supporti per cavi e cavi rivestiti in tessuto per composizioni a piacere con una o più sospensioni singole. Cavi disponibili con lunghezza su richiesta.

Cable holders and cables covered with textiles for custom settings with one or different single pendants. Custom length of cables available upon request. / Supports pour câbles et câbles recouverts en tissu pour des compositions à plaisir avec une ou plusieurs suspensions simples. Câbles disponibles avec longueur sur demande. / Kabelhalterungen und Kabel mit Stoff bezogen beliebig zusammenstellbar mit einer oder mehreren Einzel- Pendelleuchten. Kabellänge auf Anfrage. / Soportes para cables y cables revestidos en tejido para composiciones al placer con uno o más colgantes individuales. Cables disponibles con largo sobre solicitud. / Держатели проводов и провода покрыты тканью для их композиции по вкусу с одним или многочисленным подвесом. Провода доступны в запрошенной длине.



-  Bianco
-  Nero
-  Rosso
-  Vintage



ø 5 mm 2 x 0,75 mm² FEP T180° + PVC T90°	ø 1,5 ↑ 3 cm
128849 Cavo Tessuto Bianco 128832 Cavo Tessuto Nero 128825 Cavo Tessuto Rosso 149530 Cavo Tessuto Vintage	143200 Supporto Cavo Bianco 143224 Supporto Cavo Cromo 143217 Supporto Cavo Nero

GENERAL INFORMATION

GRADO DI PROTEZIONE

Degree of protection IP / Degré de protection IP / IP Schutzgrad / Grado de protección IP / Степень защиты IP

Grado di protezione espresso da due cifre. La prima si riferisce alla protezione contro l'ingresso di corpi solidi. La seconda alla protezione contro l'ingresso di liquidi. / Degree of protection expressed by two figures. The first one stands for protection against solid bodies. The second one stands for protection against liquids. / Degré de protection exprimé par deux chiffres. Le premier se réfère à la protection contre la pénétration de corps solides. Le deuxième à la protection contre l'entrée des liquides. / Schutzgrad in zwei Ziffern ausgedrückt. Die erste bezieht sich auf den Schutz gegen feste Fremdkörper. Die zweite bezieht sich auf den Schutz gegen Flüssigkeiten. / Grado de protección expresado por dos cifras. La primera se refiere a la protección contra la penetración de cuerpos sólidos. La segunda a la protección contra la penetración de líquidos. / Степень защиты выражена двумя цифрами. Первая цифра относится к защите от твердых веществ, вторая, к защите от жидкостей.

1° cifra / 1st figure / 1° chiffre / 1. Kennziffer / 1° cifra / 1-ая цифра

IP0...	Non protetto. / Not protected. / Non protégé. / Ungeschützt. / No protegida. / Нет защиты.
IP1...	Protetto contro l'ingresso di corpi solidi con Ø 50 mm. / Protected against solid objects greater than 50 mm. / Protégé contre la pénétration des corps solides avec Ø 50 mm. / Geschützt gegen feste Fremdkörper Ø 50 mm. / Protegida contra los cuerpos sólidos con un diámetro de más de Ø 50 mm. / Защита от попадания твердых веществ Ø 50 мм.
IP2...	Protetto contro l'ingresso di corpi solidi con Ø 12 mm. / Protected against solid objects greater than 12 mm. / Protégé contre la pénétration des corps solides avec Ø 12 mm. / Geschützt gegen feste Fremdkörper Ø 12 mm. / Protegida contra los cuerpos sólidos con un diámetro de más de Ø 12 mm. / Защита от попадания твердых веществ Ø 12 мм.
IP3...	Protetto contro l'ingresso di corpi solidi con Ø 2,5 mm. / Protected against solid objects greater than 2,5 mm. / Protégé contre la pénétration des corps solides avec Ø 2,5 mm. / Geschützt gegen feste Fremdkörper Ø 2,5 mm. / Protegida contra los cuerpos sólidos con un diámetro de más de Ø 2,5 mm. / Защита от попадания твердых веществ Ø 2,5 мм.
IP4...	Protetto contro l'ingresso di corpi solidi con Ø 1 mm. / Protected against solid objects greater than 1 mm. / Protégé contre la pénétration des corps solides avec Ø 1 mm. / Geschützt gegen feste Fremdkörper Ø 1 mm. / Protegida contra los cuerpos sólidos con un diámetro de más de Ø 1 mm. / Защита от попадания твердых веществ Ø 1 мм.
IP5...	Protetto contro l'ingresso di polvere. / Protected against dust infiltration. / Protégé contre la pénétration de poussière. / Staubgeschützt. / Protegida contra la penetración de polvo. / Защита от попадания пыли.
IP6...	Protetto totalmente contro l'ingresso di polvere. / Totally protected against dust infiltration. / Totalement protégé contre la pénétration de poussière. / Vollkommen staubdicht. / Totalmente protegida contra la entrada de polvo. / Полная защита от попадания пыли.

2° cifra / 2nd figure / 2° chiffre / 2. Kennziffer / 2° cifra / 2-ая цифра

IP...0	Non protetto. / Not protected. / Non protégé. / Ungeschützt. / No protegida. / Нет защиты.
IP...1	Protetto contro la caduta verticale di gocce d'acqua. / Protected against vertically falling water drops. / Protégé contre les chutes verticales de gouttes d'eau. / Geschützt gegen Vertikal-Tropfwasser. / Protegida contra la caída vertical de gotas de agua. / Защита от попадания капель воды в вертикальном падении.
IP...2	Protetto contro la caduta di acqua con inclinazione massima di 15°. / Protected against falling water drops up to 15° from the vertical. / Protégé contre les chutes d'eau en cas d'inclinaison jusqu'à 15°. / Geschützt gegen Tropfwasser mit Neigung bis 15°. / Protegida contra la caída de agua con una inclinación máxima de 15°. / Защита от попадания капель воды под углом не более 15°.
IP...3	Protetto contro la pioggia. / Protected against rain. / Protégé contre la pluie. / Geschützt gegen Regen. / Protegida contra la lluvia. / Защита от дождя.
IP...4	Protetto contro spruzzi d'acqua. / Protected against splashing water. / Protégé contre les projections d'eau. / Geschützt gegen Spritzwasser. / Protegida contra las proyecciones de agua. / Защита от брызг воды.
IP...5	Protetto contro getti d'acqua. / Protected against water jets. / Protégé contre les jets d'eau. / Geschützt gegen Strahlwasser. / Protegida contra los chorros de agua. / Защита от струи воды.
IP...6	Protetto contro potenti getti d'acqua. / Protected against powered water jets. / Protégé contre les jets d'eau puissants. / Geschützt gegen gewaltiges Strahlwasser. / Protegida contra fuertes chorros de agua. / Защита от сильной струи воды.
IP...7	Protetto contro l'immersione temporanea. / Protected against temporary immersion. / Protégé contre l'immersion temporaire. / Geschützt gegen zeitweiliges Eintauchen. / Protegida contra la inmersión temporal. / Защита от временного погружения.
IP...8	Protetto contro l'immersione prolungata. / Protected against continuous immersion. / Protégé contre l'immersion prolongée. / Geschützt gegen fortwährendes Eintauchen. / Protegida contra la inmersión continua y permanente. / Защита от продолжительного погружения.

SIMBOLI

Symbols / Symboles / Symbole / Símbolos / Символы



Lampadina inclusa

Lampadina inclusa / Bulb included / Ampoule incluse / Leuchtmittel inbegriffen / Bombilla incluida / Лампочка включена



Sorgente luminosa LED

Articoli con lampade a LED: consumo estremamente ridotto, luce chiara e concentrata, robustezza e lunga durata. / Items with LED lights: very low consumption, highly bright and focused light, strength and durability. / Articles avec lampes au LED: consommation extrêmement réduite, lumière claire et concentrée, robustesse et longue durée. / Artikel mit LED-Leuchten: extrem niedriger Verbrauch, klares und konzentriertes Licht, lange Lebensdauer. / Artículos con lámparas LED: consumo extremadamente reducido, luz clara y concentrada, robustez y larga duración. / Статьи с лампочкой LED: очень низкое потребление, свет яркий и концентрированный, прочность и надёжность в употреблении.



Driver esterno incluso

Driver esterno incluso. / External driver included. / Ballast extérieur inclus. / Externer Treiber enthalten. / Transformador externo incluido. / Внешний драйвер включен.



Lampada con interruttore integrato

Interruttore integrato nel corpo luce / Integrated switch button / Interrupteur sur la base / Schalter im Lichtkörper integriert / Interruptor encajado en el elemento de iluminación / Светильник снабжен выключателем.



Lampada con dimmer tattile

Apparecchio dotato di interruttore touch: si accende e si regola l'intensità col tocco di un dito sul corpo luce. / Lamp with touch switch: switching on and dimming by touching the base with a finger. / Appareil équipé d'interrupteur touch: il s'allume et il se règle l'intensité avec la touche d'un doigt sur la base. / Gerät mit Touch-Schalter, Einschaltung und Einstellung mit Fingertouch auf den Lichtkörper. / Equipo con interruptor touch: se enciende y se ajusta la intensidad al tocar con un dedo el elemento de iluminación. / Светильник снабжен выключателем с помощью одним дотрагиванием: включается и регулируется с помощью дотрагиванием руки к светильнику.



Lampada con dimmer

Apparecchio fornito con variatore di potenza. / Luminaire with dimmer. / Appareil équipé de variateur de lumière. / Gerät mit Leistungseinsteller. / Equipo suministrado con variador de potencia. / Светильник снабжен регулятором мощности.

Icone delle tipologie / Typology icons / Icônes des typologies / Ikonen der Typen / Iconos de las tipologías / Изображения тиологии



PL PB

Lampada da soffitto / Ceiling lamp / Plafonnier / Deckenleuchte / Lámpara de techo / Потолочные светильники



SB SP SG

Lampada a sospensione / Suspension lamp / Suspension / Pendelleuchte / Lámpara colgante / Люстры и подвесы



AP

Lampada da parete / Wall lamp / Applique / Wandleuchte / Lámpara de pared / Настенные светильники



TL

Lampada da tavolo / Table lamp / Lampe de table / Tischleuchte / Lámpara de sobremesa / Настольные лампы



PT

Lampada da terra / Floor lamp / Lampadaire / Stehleuchte / Lámpara de pie / Торшеры

INDICE PER CODICE

Code index / Index des codes / Inhaltsverzeichnis für EAN-Code / Índice por código /

Оглавление с указанием кодов

Cod.	Pag.	128825 166	135915 58	139487 48	146645 36	147246 36	149882 32	153995 156
		128832 166	135922 58	139494 48	146652 36	147253 36	149899 32	154008 156
122663 112		128849 166	135939 58	139500 48	146669 36	147260 36	149905 32	154800 106
122687 112		129167 156	135946 30	139524 48	146805 34	147277 36	149912 32	154817 106
122786 130		129433 114	135953 30	139531 48	146812 34	147284 36	149929 32	154824 106
122823 166		129440 114	135960 30	139555 50	146829 34	147291 28	149936 32	
122830 166		129457 114	135977 30	139579 50	146836 34	147307 28	149943 36	
122854 166		129464 86	135984 30	140124 102	146843 34	147314 28	149950 36	
122861 166		129471 86	135991 22	140131 102	146850 34	147321 28	149967 36	
123080 118		129488 86	136004 22	140377 90	146867 34	147338 28	149974 36	
123295 166		129495 86	136011 22	140407 90	146874 34	147345 28	149981 36	
123301 166		129501 86	136028 66	141299 164	146881 34	147352 28	149998 36	
123738 122		129518 86	136035 66	142302 104	146898 34	147369 28	150000 36	
123745 122		129525 88	136042 66	142463 108	146904 34	147376 28	150017 34	
123752 122		129532 88	136059 66	142470 108	146911 30	147383 28	150024 34	
123769 122		131955 24	136080 36	142999 56	146928 30	147390 28	150031 34	
123776 122		135205 68	136097 36	143002 56	146935 30	147406 28	150048 34	
123783 122		135212 68	136103 36	143200 166	146942 30	147413 28	150055 34	
123882 156		135229 68	136110 36	143217 166	146959 30	147420 28	150062 34	
123899 156		135236 68	136127 36	143224 166	146966 30	147437 34	150079 34	
123929 156		135250 128	136134 28	143385 102	146973 30	147765 106	151731 158	
123936 156		135366 32	136141 28	143392 90	146980 30	147772 106	151748 158	
123943 156		135373 32	136158 28	144191 34	146997 30	147789 106	151755 158	
123950 156		135380 32	136165 28	144207 30	147000 30	147796 106	151762 158	
123967 156		135397 32	136172 28	144214 36	147017 30	147802 106	151779 158	
124032 160		135410 42	136189 34	144221 28	147024 30	147819 106	151786 158	
124049 160		135427 42	136196 34	144276 118	147031 32	148922 28	151793 156	
124056 160		135441 42	136202 34	144283 116	147048 32	149455 28	151809 158	
124063 160		135489 42	136219 34	145112 28	147055 32	149462 28	151816 158	
124070 160		135519 42	136226 34	145303 76	147062 32	149479 28	151847 160	
124087 160		135533 42	137391 108	145310 76	147079 32	149486 28	151854 160	
124100 160		135755 56	137407 108	145327 76	147086 32	149493 28	151946 158	
124117 160		135762 56	138053 166	145334 76	147109 32	149509 28	151953 158	
124124 162		135779 50	138077 166	145341 76	147116 32	149523 32	151960 158	
124131 162		135786 50	138084 166	145358 76	147123 32	149530 166	151977 158	
124148 162		135793 50	138091 166	146546 34	147130 32	149738 104	151991 158	
124155 162		135809 50	138107 166	146553 34	147147 32	149745 104	152004 158	
124421 72		135830 50	138114 166	146560 34	147154 32	149783 30	153001 160	
124438 72		135847 50	138503 56	146577 30	147178 36	149790 30	153926 156	
124445 72		135854 44	138510 56	146584 30	147185 36	149806 30	153933 156	
124452 72		135861 44	138800 26	146591 30	147192 36	149813 30	153940 156	
124469 72		135878 44	138879 26	146607 32	147208 36	149844 30	153957 156	
124476 72		135885 44	138886 26	146614 32	147215 36	149851 30	153964 156	
126531 162		135892 44	138893 26	146621 32	147222 36	149868 30	153971 156	
126548 162		135908 58	139470 48	146638 32	147239 36	149875 32	153988 156	

Contatti / Contacts / Contacts / Kontakte / Contactos / Контакты

IDEAL LUX s.r.l.

Via Taglio Destro, 32
30035 Mirano (Venezia)
P.I. / C.F. 02420040277

IDEAL LUX Warehouse

Via delle Industrie, 8/D
30036 Santa Maria di Sala (Venezia)
8.00 - 12.00 / 13.30 - 17.00

IDEAL LUX Web

www.ideal-lux.com
info@ideal-lux.com

IDEAL LUX Office

Tel. +39 041 6790500
Fax +39 041 8872349
8.00 - 12.00 / 13.30 - 17.30